



**CATALOGUE**

**2024**

**ITALIAN FOG SYSTEMS**  
QUALITY EXPERIENCE





# ITALFOG'S WORLD TECHNOLOGY MISTING SYSTEMS



## SOLUTIONS FOR PROFESSIONAL NEEDS





Project Design



Technical Support



Distribution



Outdoor Cooling



Humidification



Dust Control

## ITALFOG Outdoor Cooling, Humidification Control Odor and Dust Solutions

ITALFOG specializes in distribution of **outdoor cooling systems** and makes fog systems for **cooling, humidification, special effects, dust control, odor neutralization in the home, commercial, industrial and agricultural fields.**

All Italfog products are made in Italy and respect all Italian and European quality standard. For this reason many importers have chosen Italfog for the high capacity in delivering High Quality products at the best competitive price.

### VISION

As a capable and dependable partner, Italfog takes an interest in its own customer's ideas, and get to know their needs and requirements via direct dialogue with them. On this basis Italfog can then work with its customers to come up with comprehensive, innovative solutions.

### QUALITY

Italfog is committed to providing customers with the best quality products (**misting pumps, nozzles, fittings, fans, control devices, portable misting systems**), for the most competitive price without sacrificing quality. Italfog uses the best materials, equipment and proven quality control methods to produce the finest pumps and parts found in the market today.

### PROJECT DESIGN AND AUTOMATION SYSTEMS

Project design is one of the services that Italfog offers to all customers all over the world. Design plans to help projects get done quickly, efficiently, and safely. Thanks to Italfog's experience in **automation systems** it's possible to personalize misting systems applications using supervision systems (PLC, HMI) designed and realized by Italfog.

### ITALIAN PRODUCTS FOR PROFESSIONAL NEEDS





Italfog misting systems can provide outdoor cooling reducing temperatures by up to 40 degrees Fahrenheit with virtually no noticeable increase in the relative humidity.

## APPLICATION

### RESIDENTIAL

- Dehors, terraces and gardens

### COMMERCIAL

- Dehors, tends, terraces, restaurant, hotel
- Resorts, villages
- Sporting center
- In house with big and large areas

### INDUSTRIAL

- Warehouses
- Precooling HVAC
- Workshops
- Greenhouses
- Livestock - (buffalos, horses, poultry, and so on)

## TIPYCAL MISTING SYSTEMS

*Pipes, nozzles, fans, high pressure pumps.*

## BENEFITS

- Reduced investment level
- Low maintenance costs
- Low energy consumption
- Improvement Air quality
- Temperatures reduction up to 10°C
- Improvement work quality
- Increase productivity

**For significant improvements in the performance of any climate control system, contact the Italfog Customer Service Department for system consultation and design assistance.**



### ITALFOG RECOMMENDS



### LIBERTY DELUXE

Kit from 10 up to 75 nozzles  
AP PUMP OASIS PRO TIME





Misting systems are considered an ideal means of climate control in many industries where humidity and temperature are critical to improve profitability.

## APPLICATION

### INDUSTRIAL/COMMERCIAL

- Warehouses - Food
- Fruits display - Market
- Fish display
- Greenhouses
- Wine storage
- Refrigerating room
- Textile facilities
- Paper production
- Tobacco storages

### TYPICAL MISTING SYSTEMS

*High pressure pump, nozzles and device control to check humidity level.*

### BENEFITS

- Reduced investment level
- Low maintenance costs
- Low energy consumption
- Reduce waste and counteract the weight loss
- Increase sales
- Increase profit margins

**For significant improvements in the performance of any climate control system, contact the Italfog Customer Service Department for system consultation and design assistance.**



### ITALFOG RECOMMENDS



Kit from 10 up to 70 nozzles  
HP PUMP OASIS C3 HT



antibacterial filters  
9" - 0.005 + 1 + 5 micron



Humidity and Temperature  
probe



Misting systems are an effective method for dust suppression and air filtration. By producing a large percentage of 10 micron fog droplets, dust particles are absorbed by the mist and fall to the ground.

## APPLICATIONS

### INDUSTRIAL

- Quarries
- Marble quarries
- Bodies shop
- Woodworking
- Building
- Landfill

### TIPYCAL MISTING SYSTEMS

*High pressure pump, nozzles*

### BENEFITS

- Low cost investment
- Low maintenance costs
- Low energy consumption
- Dust control
- Improvement work quality
- Increase productivity

For significant improvements in the performance of a misting system for dust control, contact the Italfog Customer Service Department for system consultation and design assistance.



### ITALFOG RECOMMENDS



Kit from 10 up to 75 nozzles  
HP PUMP OASIS PRO



Device control



High pressure misting systems are extremely effective at eliminating odors associated with solid waste treatment facilities and microbial decomposition of animal waste.

## APPLICATION

### INDUSTRIAL

- Landfill
- Oil industry
- Leather industry
- Food waste storage

### TIPYCAL MISTING SYSTEMS

*High pressure pumps, nozzles and dosing pumps*

### BENEFITS

- Low investment cost
- Low maintenance costs
- Low energy consumption
- Improvement Air quality
- Odor control
- Improvement work quality

To help determine the best solution for your specific odor control problem, contact the Italfog Customer Service Department for system consultation and design assistance.



### ITALFOG RECOMMENDS



Kit from 10 up 75 nozzles  
HP PUMP OASIS PRO KEM



Dosing pump and  
natural perfumes





## HIGH PRESSURE PUMPS GROUPS PREMIUM-PROFESSIONAL

---



All HP pump are equipped with Scudokal anti calcium scale component. Total protection on hydraulics circuits and nozzles.



[www.scudokal.com](http://www.scudokal.com)

## OASIS PREMIUM series



Dimensions: l. 400 w. 300 h. 270 mm  
Weight: 20 Kg. - 550-1250W

### Oasis PREMIUM PLUS 1-6Lit/min 1000 PSI - 230V/50/60Hz

These **professional** high pressure pumps offer the best solution for small misting systems project with flow rates ranging **from 1 up to 6 liters/min.** driven by single-phase motors.

OASIS P. PLUS	IF307141	IF307142	IF307143	IF307144	IF307145
Output l/pm	1	2	3	4	6

Nozzles: 8-75



Dimensions: l. 490 w. 410 h. 300 mm  
Weight: 22-25 Kg - 550-1250W

### Oasis PREMIUM TIME 1-6 Lit/min - 1000 PSI - 230V/50/60Hz

This pump is suitable for small and medium humidification systems thanks to the special programming of the built-in timer that allows you to set work cycles in seconds and pause cycles in minutes. The Flow rate range goes from 1 up to 6 Lit/min

OASIS P. TIME	IF307041	IF307042	IF307043	IF307044	IF307045
Output l/pm	1	2	3	4	6

Nozzles: 8-75



Dimensions: l. 472 w. 374 h. 332 mm  
Weight: 20-22 Kg. - 550-1250W

### Oasis HT 1-6 Lit/min - 1000 PSI - 230V/50/60Hz

This pump is suitable for professional and medium humidification systems thanks to the special programming of the built-in timer that allows you to set work cycles in seconds and pause cycles in minutes. The Flow rate range goes from 1 up to 6 Lit/min. A built-in **humidity and temperature** controller grants a complete control on environment conditions and a quick and simple installation of humidification systems.

OASIS -HT	IF307241	IF307242	IF307243	IF307244	IF307246
Output l/pm	1	2	3	4	6

Nozzles: 8-130

**Reccomended for Humidification**



## OASIS PRO EVOLUTION series



### Oasis Pro 1-6Lit/min 1000 PSI - 230V/50/60Hz

These series of professional high pressure pumps are the suitable solution with high quality and safety standard for all requirements to build professional misting systems with flow rates ranging from 0.6 up to 6 l/min with single phase electric motor. This serie is available with Timer and No Timer.

OASIS PRO T	IF307056	IF307050	IF307058	IF307051	IF307052
Output l/pm	1	2,5	3	4	6

Nozzles: 8-75



### Oasis Pro KEM: 1-6Lit/min - 1000 PSI - 230V/50/60Hz

These series of professional high pressure pumps are the suitable solution for **dust and odor suppression** or **sanitizing by chemicals spreading**. Flow rates ranging from 1 to 6 l/min, single-phase electric motor.

OASIS PRO TK	IF308056	IF308050	IF308058	IF308051	IF308052
Output l/pm	1	2,5	3	4	6

Nozzles: 8-75



### Oasis Pro 2: 8-12Lit/min - 1000 PSI - 230/400V - 50/60Hz

These series of **professional** high pressure pumps are the suitable solution with high quality and safety standard for all requirements to build professional misting systems with flow rates ranging from 8 up to 12 liters/min. with single-phase or three-phase electric motor.

OASIS PRO 2T	IF307153	IF307154	IF307155
Output l/pm	8,5	10	12

Nozzles: 75-150



### Oasis Pro 3: 15-43Lit/min - 1000 PSI - 400V - 50/60HZ

These series of professional high pressure pumps are the suitable solution with high quality and safety standard for all requirements to build professional misting systems with flow rates ranging from 15 up to 43 l./min. with three-phase electric motor. Available in Time version too.

OASIS PRO 3	IF308111	IF308112	IF308113	IF308114	IF308115	IF308115
Output l/pm	15	18	21	27	35	43

Nozzles: 150-545

Recommended for  
Cooling  
Dust and Odor Control  
Humidification



## OASIS PRO EVOLUTION VAR series



### Oasis XPRO 5 1-5Lit/min 1000 PSI - 230V/50/60Hz

These series of var professional high pressure pumps are the suitable solution with high quality and safety standard for all requirements to build professional misting systems with flow rates ranging from 1 up to 5 l/min with single phase electric motor.

OASIS XPRO 5	IF308084	IF308085
Output l/pm	0,5-2,5	1-5
<b>Nozzles: 5-60</b>		



### Oasis XPro18: 1-18Lit/min - 1000 PSI - 400V/50/60Hz

These series of var professional high pressure pumps are the suitable solution with high quality and safety standard for all requirements to build professional misting systems with flow rates ranging from 1 up to 18 l./min. with three-phase electric motor.

OASIS XPRO 18	IF308082	IF308080	IF308081
Output l/pm	1-10	1,5-15	2-18
<b>Nozzles: 12-230</b>			

Reccomended for  
Cooling  
Dust and Odor Control  
Humidification









## PIPES AND FITTINGS

---



## Standard 3/8" Push-In fittings and tubing for POLYAMMIDE line



Cod.	Description	Cod.	Description
 IF300001	Raccordo portaugello ad innesto 3/8" con 1 foro 10/24" 3/8" Fitting for nozzle 10/24"	 IF400021	Tubo alta pressione PA-RIGID 3/8" in rotolo 25 mt. - BIANCO 3/8" nylon tubing in coil form 25 mt. PA-RIGID - WHITE
 IF300002	Raccordo portaugelli per 2 ugelli da 10/24" ad innesto 3/8" 3/8" Fitting for 2 nozzles 10/24"	 IF400022	Tubo alta pressione PA-RIGID pretagliata 80 cm - BIANCO 80 cm length nylon straight tubing 3/8" PA-RIGID - WHITE
 IF300003	Raccordo unione ad innesto 3/8" 3/8" tube coupling	 IF400027	Graffa fissatubo da 3/8" in acciaio con guarnizione BIANCA Clamp for 3/8" tubing WHITE
 IF300013	Raccordo portaugello ad innesto di fine linea 3/8" End Fitting for 1 nozzle	 IF400001	Tubo alta pressione PA-RIGID 3/8" in rotolo 25 mt. - NERO 3/8" nylon tubing in coil form 25 mt. PA-RIGID - BLACK
 IF300004	Raccordo a Tee ad innesto 3/8" 3/8" T Fitting	 IF400004	Tubo alta pressione PA-RIGID 3/8" in rotolo 50 mt. - NERO 3/8" nylon tubing in coil form 50 mt. PA-RIGID - BLACK
 IF300005	Raccordo curva 90 ad innesto 3/8" 3/8" L Fitting	 IF400003	Tubo alta pressione PA-RIGID 3/8" in rotolo 100 mt. - NERO 3/8" nylon tubing in coil form 100 mt. PA-RIGID - BLACK
 IF300026	Raccordo inizio 3/8" tubo x 1/4" BSP 1/4" BSP male connector for 3/8" tube	 IF400002	Tubo alta pressione PA-RIGID pretagliata 80 cm - NERO 80 cm length nylon straight tubing 3/8" PA-RIGID - BLACK
 IF300010	Adattatore Tubo-Ugello tubo 3/8"-ugello 10/24" 3/8" tube to nozzle adaptor	 IF400007	Graffa fissatubo da 3/8" in acciaio con guarnizione - NERA Clamp for 3/8" tubing - BLACK
 IF300009	Tappo di fine linea da 3/8" 3/8" end plug	 IF400010	Pinza tagliatubi in metallo per tubi fino a 1/2" High quality tubing cutter
 IF400009	Valvola a sfera di intercettazione con raccordi innesto 3/8" - 80 bar 3/8" On/Off slip lock Valve - 1150 psi		

**NOXIDE**  
Oxidation-Acids  
Resistive coating



**i** Disponibili anche nella versione 1/4" - 5mm  
Pipes and fittings available in 1/4" - 5mm size

- 3/8" tubing = Ø 9,52 mm
- Pressione nominale - Operating pressure: 100 bar (1450 psi)
- Pressione max. consentita - Max allowed pressure: 130 bar (1890 psi)
- Max. misting line length - Lunghezza massima linea: 90 m (300 Ft)
- Max. flow rate - Portata massima linea: 11 l/min (2.9 Gpm)

## Standard 3/8" Push-In fittings and tubing for POLYAMMIDE line



Cod.	Description
<b>IF300006</b>	Raccordo a croce 4 vie ad innesto 3/8" 3/8" four way (X) cross fitting



Cod.	Description
<b>IF300008</b>	Connettore per 6 ugelli ad ombrello ad innesto 3/8" 3/8" 6 nozzles misting umbrella



Cod.	Description
<b>IF300030</b>	Connettore per linea a stella 1 IN + 6 OUT x 3/8" Tube connector 1 to 6 for 3/8" pipe



## Special Push-In fittings and tubing for POLYAMMIDE line



Cod.	Description
<b>IF300011</b>	Raccordo inizio 3/8" tubo x 3/8"Npt 3/8" Male connector for 3/8" tube



Cod.	Description
<b>IF300014</b>	Raccordo di unione diritta 1/2" 1/2" Tube coupling



Cod.	Description
<b>IF300015</b>	Giunzione ridotta 1/2" x 3/8" 1/2"-3/8" adaptor



Cod.	Description
<b>IF300016</b>	Raccordo innesto a T 1/2" 1/2" T Fitting



Cod.	Description
<b>IF300017</b>	Raccordo innesto T 1/2"-3/8"-1/2" 1/2"-3/8"-1/2" T Fitting



Cod.	Description
<b>IF300018</b>	Tappo di fine linea 1/2" 1/2" end plug



Cod.	Description
<b>IF300021</b>	Raccordo inizio 1/2" tubo x 1/2" 1/2" male connector for " tube



Cod.	Description
<b>IF400008</b>	Graffa fissatubo da 1/2" in acciaio con guarnizione Clamp for 1/2" tubing



















Cod.	Description
<b>IF400006</b>	Tubo alta pressione PA-RIGID in rotolo 25 mt. 1/2" nylon tubing in coil form 25 mt. PA-RIGID

**NOXIDE**  
Oxidation-Acids  
Resistive coating

- 1/2" tubing = Ø 12,5 mm
- Pressione nominale - Operating pressure: 100 bar (1450 psi)
- Pressione max. consentita - Max allowed pressure: 130 bar (1890 psi)

## Standard 1/4" Push-In fittings and pipes for POLYAMIDE line

Raccordi 1/4" ad innesto rapido e tubi linea POLYAMIDE

Cod.	Description	Cod.	Description
 IF304001	Raccordo portaugello ad innesto 1/4" con 1 foro 10/24" 1/4" Fitting for nozzle 10/24"	 IF404021	Tubo alta pressione PA-12 1/4" rotolo 25 mt. - BIANCO 1/4" nylon tubing in coil form 25 mt. PA-12 - WHITE
 IF304003	Raccordo unione ad innesto 1/4" 1/4" tube coupling	 IF404022	Tubo alta pressione 1/4" PA-12 verga 80 cm - BIANCO 80 cm length nylon straight tubing 1/4" PA-12 - WHITE
 IF304013	Raccordo portaugello ad innesto di fine linea 1/4" 1/4" End Fitting for 1 nozzle	 IF404027	Graffa fissatubo da 1/4" inox con guarnizione BIANCA S.Steel clamp for 1/4" tubing WHITE
 IF304004	Raccordo a Tee ad innesto 1/4" 1/4" T Fitting	 IF404001	Tubo alta pressione PA-12 1/4" in rotolo 25 mt. - NERO 1/4" nylon tubing in coil form 25 mt. PA-12 - BLACK
 IF304005	Raccordo curva ad innesto 1/4" 1/4" L Fitting	 IF404002	Tubo alta pressione 1/4" PA-12 verga 80 cm - NERO 80 cm length nylon straight tubing 1/4" PA-12 - BLACK
 IF304026	Raccordo inizio 1/4" tubo x 1/4" BSP-P 1/4" BSP-P male connector for 1/4" tube	 IF404007	Graffa fissatubo da 1/4" inox con guarnizione - NERA S.Steel clamp for 1/4" tubing - BLACK
 IF304015	Giunzione tubo 1/4" 3/8" Union - 1/4" to 3/8" pipe connector	 IF400010	Pinza tagliatubi di alta qualità per tubi dia. max. 1/2" High quality tubing cutter. Max pipe size 1/2"
 IF304009	Tappo di fine linea da 1/4" 1/4" end plug		
 IF304006	Raccordo a croce a 4 vie ad innesto 1/4" 1/4" four way (X) cross fitting		
 IF404009	Valvola a sfera di intercettazione con raccordi innesto 1/4" - 80 bar 1/4" On/Off slip lock Valve - 1150 psi		

1000 psi series  
serie 70 bar

- PA12 1/4" tubing  $\varnothing = 6.35$  mm
- Pressione nominale - Operating pressure: 100 bar (1500 psi)
- Pressione max. (scoppio) - Burst pressure: 250 bar (3600 psi)
- Max. misting line length (ring) - Lunghezza massima linea (anello): 200 m - (650 Ft)
- Max. flow rate - Portata massima linea: 6 l/min (1.59 Gpm)

**NOXIDE**  
Oxidation-Acids  
Resistive coating



## Raccordi 5mm ad innesto rapido e tubi linea POLYAMMIDE

Standard 5mm Push-In fittings and tubing for POLYAMMIDE line



Cod.	Description
 IF300071	Raccordo portaugello ad innesto 5 mm con 1 foro 10/24" 5 mm fitting for one nozzle 10/24"
 IF300072	Raccordo unione ad innesto 5 mm 5 mm tube coupling
 IF300077	Raccordo 10/24" M x tubo 5 mm 10/24" M to 5 mm tube adapter
 IF300074	Raccordo portaugello ad innesto di fine linea 5 mm con foro 10/24" 5 mm end fitting for one nozzle 10/24"
 IF300075	Raccordo inizio 5 mm x 1/4" F BSP 1/4" BSP female connector for 5 mm tube
 IF300076	Raccordo inizio 5 mm x 1/4" M BSP 1/4" BSP male connector for 5 mm tube
 IF400025	Tubo alta pressione PA-RIGID 5mm in rotolo 50 mt. - BIANCO 5 mm nylon tubing in coil form 50 mt. PA-RIGID - WHITE
 IF400026	Tubo alta pressione PA-RIGID 5mm in rotolo 50 mt. - NERO 5 mm nylon tubing in coil form 50 mt. PA-RIGID - BLACK
 IF400028	Graffa fissatubo 5mm e 3/16" in acciaio con guarnizione S.Steel clamp for 5mm or 3/16" tubing IF500005



**i** Disponibili anche nella versione 1/4" - 3/8"  
Pipes and fittings available in 1/4" - 3/8" size

**NOXIDE**  
Oxidation-Acids  
Resistive coating

**La notevole flessibilità dei tubi in polyamide da 5 mm unite alle piccole dimensioni dei raccordi, consentono di adattare con la massima semplicità i sistemi di nebulizzazione ad ombrelloni, tende, sagome curve.**





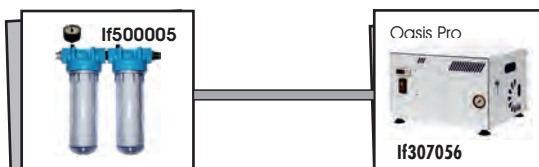







**The remarkable flexibility of 5 mm polyamide tubing combined with small size fittings allow to easily adapt misting systems to umbrellas, tents, curved shapes.**

Recommanded Kit



- 5 mm polyamide tubing - Tubi polyamide 5 mm
- Pressione nominale - Operating pressure: 70 bar (1000 psi)
- Pressione max. (scoppio) - Burst pressure: 130 bar (1890 psi)
- Max. misting line length - Lunghezza massima linea: 30 m (100 Ft)
- Max. flow rate - Portata massima linea: 4 l/min (1 Gpm)

## Linea ACCIAIO INOX 10 mm e raccordi 10 mm STAINLESS STEEL PIPES and fittings

Cod.	Description
 IF614101	Portaugello INOX 10mm - 1 foro 10/24unc/2B S.Steel 10mm Nozzle holder - 1 hole 10/24
 IF614102	Portaugello INOX 10mm - 2 fori 10/24unc/2B 180° S.Steel 10mm Nozzle holder - 2 holes 10/24 180°
 IF614103	Portaugello INOX 10mm - 2 fori 10/24unc/2B 120° S.Steel 10mm Nozzle holder - 2 holes 10/24 120°
 IF614120	Raccordo a T INOX (10 x 10 x 10 mm) S.Steel Tee fitting (10 x 10 x 10 mm)
 IF614121	Raccordo Curva 90 INOX (10 x 10 mm) S.Steel Union Elbow (10 x 10 mm)
 IF614122	Giunzione femmina INOX (BSP 1/4"F x 10mm) S.Steel Union - female connector (BSP 1/4"F x 10mm)
 IF614123	Giunzione tubo 10 mm INOX (10 x 10 mm) Union - pipe connector (10 x 10 mm)
 IF614124	Giunzione tubo 12-10 mm INOX (12 x 10 mm) Union - pipe connector (12 x 10 mm)
 IF614125	Raccordo a croce INOX 4 vie 10mm S.Steel 10mm four way (X) cross fitting
 IF614127	Giunzione maschio INOX (BSP 1/4"M x 10mm) S.Steel Union - male connector (BSP 1/4"M x 10mm)
 IF614126	Tappo di chiusura INOX per raccordi 10mm S.Steel end plug for 10mm fittings
 IF614129	Busta 50 pz. OR Viton ricambio portaugello Inox 10mm Viton O-Rings for 10mm SS nozzle fitting - 50 pcs. bag

new

**INOX**  
Oxidation-resistant  
**S.STEEL**

### Raccordi orientabili - Adjustable fittings

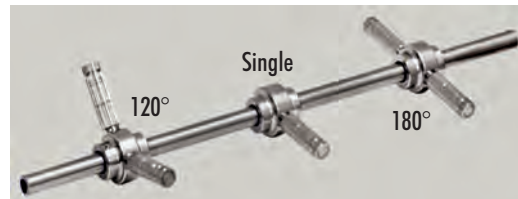
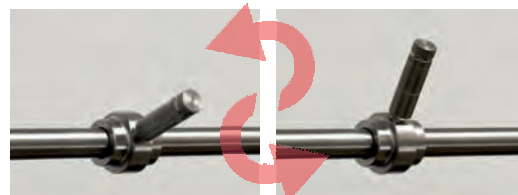

Cod.	Description
IF713100	Tubo in acciaio INOX 10x1 mm : 100cm S.Steel pipe 10x1mm : 100cm

IF713200	Tubo in acciaio INOX 10x1 mm : 200cm S.Steel pipe 10x1mm : 200cm
----------	---

### Installazione raccordi orientabili Adjustable fittings installation



Eeguire un foro min. 3 e max. 5 mm. Rimuovere eventuali bave.  
Drill a hole of min. 3 and max. 5 mm diameter. Remove all burrs.



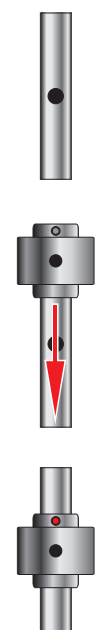

Lubrificare l'interno del raccordo per facilitare lo scorrimento e posizionarlo in corrispondenza del foro. Lubricate the fitting O-rings then move it above the pre-drilled hole.

Fissare la vite a grano per evitare lo scorrimento del raccordo sul tubo. Secure the fitting by tightening the small screw. This will avoid sidewise sliding.



- Tubazione 10x1 mm - 10x1 mm tubing
- Pressione nominale - Operating pressure: 100 bar (1450 psi)
- Pressione max. consentita - Max allowed pressure: 130 bar (1890 psi)
- Coppia di serraggio standard filetti e anelli conici: 85 Nm
- Standard tightening torque for threads and ferrules: 85 Nm

## Linea ACCIAIO INOX 12 mm e raccordi 12 mm STAINLESS STEEL PIPES and fittings

Cod.	Description
 IF614201	Portaugello INOX 12mm - 1 foro 10/24unc/2B S.Steel 12mm Nozzle holder - 1 hole 10/24
 IF614202	Portaugello INOX 12mm - 2 fori 10/24unc/2B 180 S.Steel 12mm Nozzle holder - 2 holes 10/24 180
 IF614220	Raccordo a T INOX (12 x 12 x 12 mm) S.Steel Tee fitting (12 x 12 x 12 mm)
 IF614221	Raccordo Curva 90 INOX (12 x 12 mm) S.Steel Union Elbow (12 x 12 mm)
 IF614222	Giunzione femmina INOX (BSP 3/8"F x 12mm) S.Steel Union - female connector (BSP 3/8"F x 12mm)
 IF614223	Giunzione tubo 12 mm INOX (12 x 12 mm) Union - pipe connector (12 x 12 mm)
 IF614224	Giunzione tubo 15-12 mm INOX (15 x 12 mm) Union - pipe connector (15 x 12 mm)
 IF614225	Raccordo a croce INOX 4 vie 12mm S.Steel 12mm four way (X) cross fitting
 IF614226	Tappo di chiusura INOX per raccordi 12mm S.Steel end plug for 12mm fittings
 IF614229	Busta 50 pz. OR Viton ricambio portaugello Inox 12mm Viton O-Rings for 12mm SS nozzle fitting - 50 pcs. bag

new

**INOX**  
Oxidation-resistant  
**S.STEEL**

### Raccordi orientabili - Adjustable fittings

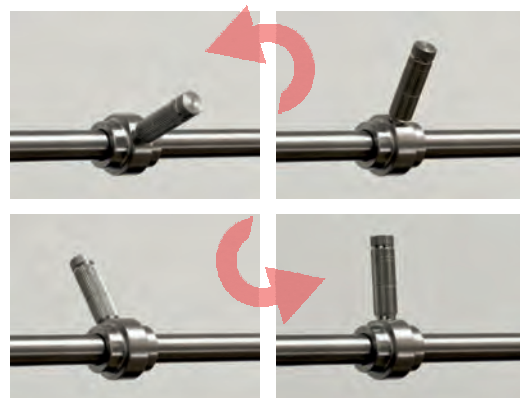

Cod.	Description
IF714100	Tubo in acciaio INOX 12x1 mm : 100cm S.Steel pipe 12x1mm : 100cm
IF714200	Tubo in acciaio INOX 12x1 mm : 200cm S.Steel pipe 12x1mm : 200cm

#### Installazione raccordi orientabili Adjustable fittings installation



Eeguire un foro min. 3 e max. 5 mm. Rimuovere eventuali bave.  
Drill a hole of min. 3 and max. 5 mm diameter. Remove all burrs.

Lubrificare l'interno del raccordo per facilitare lo scorrimento e posizionarlo in corrispondenza del foro.  
Lubricate the fitting O-rings then move it above the pre-drilled hole.

Fissare la vite a grano per evitare lo scorrimento del raccordo sul tubo.  
Secure the fitting by tightening the small screw. This will avoid sideways sliding.

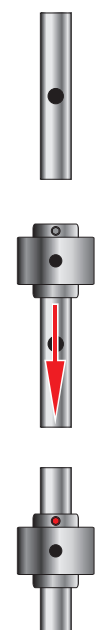

- Tubazione 12x1 mm - 12x1 mm tubing
- Pressione nominale - Operating pressure: 100 bar (1450 psi)
- Pressione max. consentita - Max allowed pressure: 130 bar (1890 psi)
- Coppia di serraggio standard filetti e anelli conici: 120 Nm
- Standard tightening torque for threads and ferrules: 120 Nm



## NOZZLES / ACCESSORIES

---



## UGELLI NEBULIZZATORI e ACCESSORI

### CLEANABLE NOZZLES and ACCESSORIES

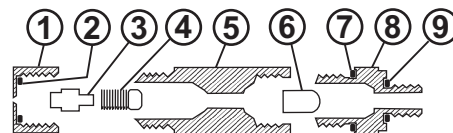

HCN 10/24" Ugello ripulibile Noxide/acciaio inossidabile - HCN 10/24" type Noxide/S.Steel Nozzle

Testata e deflettore estraibile in acciaio inox per assicurare un ottima pulizia

With Stainless Steel head and impeller plate, which is able to be taken apart for cleaning

Con valvola antigoccia e filtro da 25 micron - With anti-drip check valve and 25 micron filter

Cod.	Item No.	Orifice	Anti-drip type	Prezzo/Price
IF130159		0.15mm	EPDM 55	
IF130209		0.20mm	EPDM 55	
IF130309		0.30mm	EPDM 55	
IF130409		0.40mm	EPDM 55	
IF130509		0.50mm	EPDM 55	

**NOXIDE**  
Oxidation-Acids  
Resistive coating



HCN 10/24" Ugello ripulibile completamente in acciaio inossidabile - HCN 10/24" type Stainless Nozzle

Testata e deflettore estraibile in acciaio inox per assicurare un ottima pulizia

With Stainless Steel head and impeller plate, which is able to be taken apart for cleaning

Con valvola antigoccia e filtro da 25 micron - With anti-drip check valve and 25 micron filter

Cod.	Item No.	Orifice	Anti-drip type	Prezzo/Price
IF140159		0.15mm	Viton 55	
IF140209		0.20mm	Viton 55	
IF140309		0.30mm	Viton 55	
IF140409		0.40mm	Viton 55	
IF140509		0.50mm	Viton 55	

**S. STEEL**  
Oxidation-Acids  
Resistive metal



HCN Testina ugello in acciaio inossidabile - HCN type Stainless Steel Nozzle head ONLY

Con deflettore estraibile in acciaio inossidabile per assicurare un ottima pulizia - Senza valvola antigoccia

With stainless impeller plate, which is able to be taken apart for cleaning - Without anti-drip check

Cod.	Item No.	Orifice	Anti-drip type	Prezzo/Price
IF240151		0.15mm	---	
IF240201		0.20mm	---	
IF240301		0.30mm	---	
IF240401		0.40mm	---	
IF240501		0.50mm	---	

**S. STEEL**  
Oxidation-Acids  
Resistive metal



HCN spare parts - Parti di ricambio per ugelli serie HCN

Cod.	Item No.	Prezzo/Price
IF200007	Molla calibrata x sistema antigoccia ugello - Antidrip nozzle spring	
IF200010	O-Ring 10/24" NBR - O-Ring 10/24"	
IF200012	Nozzle head O-Ring EPDM - O-Ring testina ugello	

1-Testina 2- O-Ring 3-Pistoncino antigoccia 4-Molla antigoccia 5-Corpo 6-Filtro 7-O-Ring 8-Corpo 9-O-ring  
1-Head 2-O-Ring 3-Anti-drip piston 4-Anti-drip spring 5-Body 6-Filter 7-O-Ring 8-Body 9-O-ring

## UGELLI NEBULIZZATORI e ACCESSORI

### CLEANABLE NOZZLES and ACCESSORIES

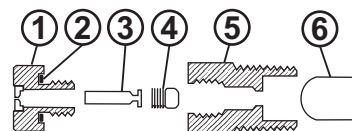

Cod.	Item No.	Orifice	Anti-drip type	
	<b>IF730154</b>	0.15mm	EPDM	55
	<b>IF730204</b>	0.20mm	EPDM	55
	<b>IF730304</b>	0.30mm	EPDM	55
	<b>IF730404</b>	0.40mm	EPDM	55
	<b>IF730504</b>	0.50mm	EPDM	55

TCN 1/8" NPT Ugello ripulibile completamente in acciaio inox - TCN 1/8" NPT type

Con deflettore estraibile in acciaio inossidabile per assicurare un'ottima pulizia

With stainless impeller plate, which is able to be taken apart for cleaning

Con valvola antigoccia e filtro da 60 micron - With anti-drip check valve and 60

**NOXIDE**  
Oxidation-Acids  
Resistive coating



Cod.	Item No.	Orifice	Anti-drip type	
	<b>IF740154</b>	0.15mm	Viton	55
	<b>IF740204</b>	0.20mm	Viton	55
	<b>IF740304</b>	0.30mm	Viton	55
	<b>IF740404</b>	0.40mm	Viton	55
	<b>IF740504</b>	0.50mm	Viton	55

UCN 10/24" Ugello ripulibile noxide/acciaio inossidabile - UCN 10/24" type

Con deflettore estraibile e lavabile in acciaio inox - Con valvola antigoccia

With Stainless Steel impeller plate, which is able to be taken apart for cleaning - Anti-

Senza filtro **SERIE ECONOMY** - Without filter - **ECONOMY SERIES**

**S.STEEL**  
Oxidation-Acids  
Resistive metal



Cod.	Item No.	Orifice	Anti-drip type	
	<b>IF030152</b>	0.15mm	EPDM	55
	<b>IF030202</b>	0.20mm	EPDM	55
	<b>IF030302</b>	0.30mm	EPDM	55
	<b>IF030402</b>	0.40mm	EPDM	55
	<b>IF030502</b>	0.50mm	EPDM	55
	<b>IF030802</b>	0.80mm	EPDM	55
	<b>IF031002</b>	1,00mm	EPDM	55

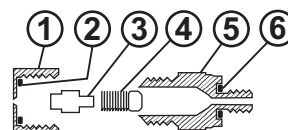

**NOXIDE**  
Oxidation-Acids  
Resistive coating



Tappo esclusione ugello in ottone nichelato - Nickel-plated brass Nozzle Plug

Cod.	Item No.	Description
	<b>IF080007</b>	*Brass Nozzle Plug *Filettatura - Thread No.: 10/24unc/2A



Tappo esclusione ugello in acciaio inox - S.Steel Nozzle Plug

Cod.	Item No.	Description
	<b>IF060007</b>	*Stainless Steel Nozzle Plug *Filettatura - Thread No.: 10/24unc/2A

1-Testina 2-O-Ring 3-Pistoncino antigoccia 4-Molla antigoccia 5-Corpo 6-Filtro / 6-O-Ring  
1-Head 2-O-ring 3-Anti-drip piston 4-Anti-drip spring 5-Body 6-Filter / 6-O-Ring

## UGELLI NEBULIZZATORI e ACCESSORI

### CLEANABLE NOZZLES and ACCESSORIES

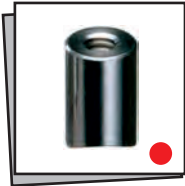

Cod.	Item No.	Description
IF651101		#SG-10SS – 12.7 * Manicotto a saldare in acciaio - Stainless Spigot * Filetto - Thread No.: 10/24unc/2B * Per tubo diam. 1/2" (12.7mm) * For dia 1/2" (12.7mm) pipe



Cod.	Item No.	Description
IF651181		#SG-18SS – 12.7 – A type * Manicotto a saldare in acciaio - Stainless Spigot * Filetto - Thread No.: 1/8-27NPT Female * Per tubo diam. 1/2" (12.7mm) * For dia 1/2" (12.7mm) pipe



#### Valvola ugello di scarico (antigoccia) in ottone - Brass Nozzle Drain Valve



Cod.	Item No.	Description
IF200008		*Brass Nozzle Drain Valve *Filettatura - Thread No.: 10/24unc/2A

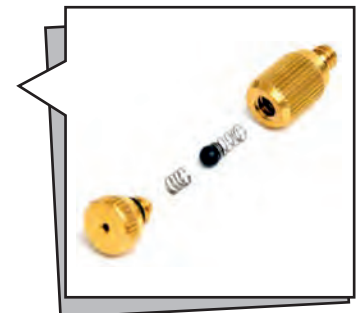

#### Filtri acqua per ugelli - Nozzle water filters



Cod.	Item No.	Description
IF403251	100	
IF403252	10000	* Filtro polyethylene 25 micron * 25 micron polyethylene filter *Diam. - Dia.: .161 - .177 / 4.10 – 4.50 *Lunghezza - Length: .224 - .248 / 5.70 – 6.30 * Per filetto - For thread #12/24unc/2B



Cod.	Item No.	Description
IF403601	100	
IF403602	10000	* Filtro polyethylene 60 micron * 60 micron polyethylene filter * Diam. - Dia.: .250 - .267 / 6.35 – 6.78 * Lunghezza - Length: .325 - .355 / 8.26 – 9.02 * Per filetto - For thread 1/8-27NPT Male

#### Altri accessori per ugelli - Other nozzle accessories



Cod.	Item No.	Description
IF200006		Cacciavite stringiugello EC - Nozzle handtool

## UGELLI NEBULIZZATORI e ACCESSORI

### CLEANABLE NOZZLES and ACCESSORIES

**NOXIDE**  
Oxidation-Acids  
Resistive coating

Prolunghe per ugelli in Ottone  
Brass nozzle extenders

Prolunghe flessibili in Ottone-Rame  
Flexible Brass-Copper nozzle extenders

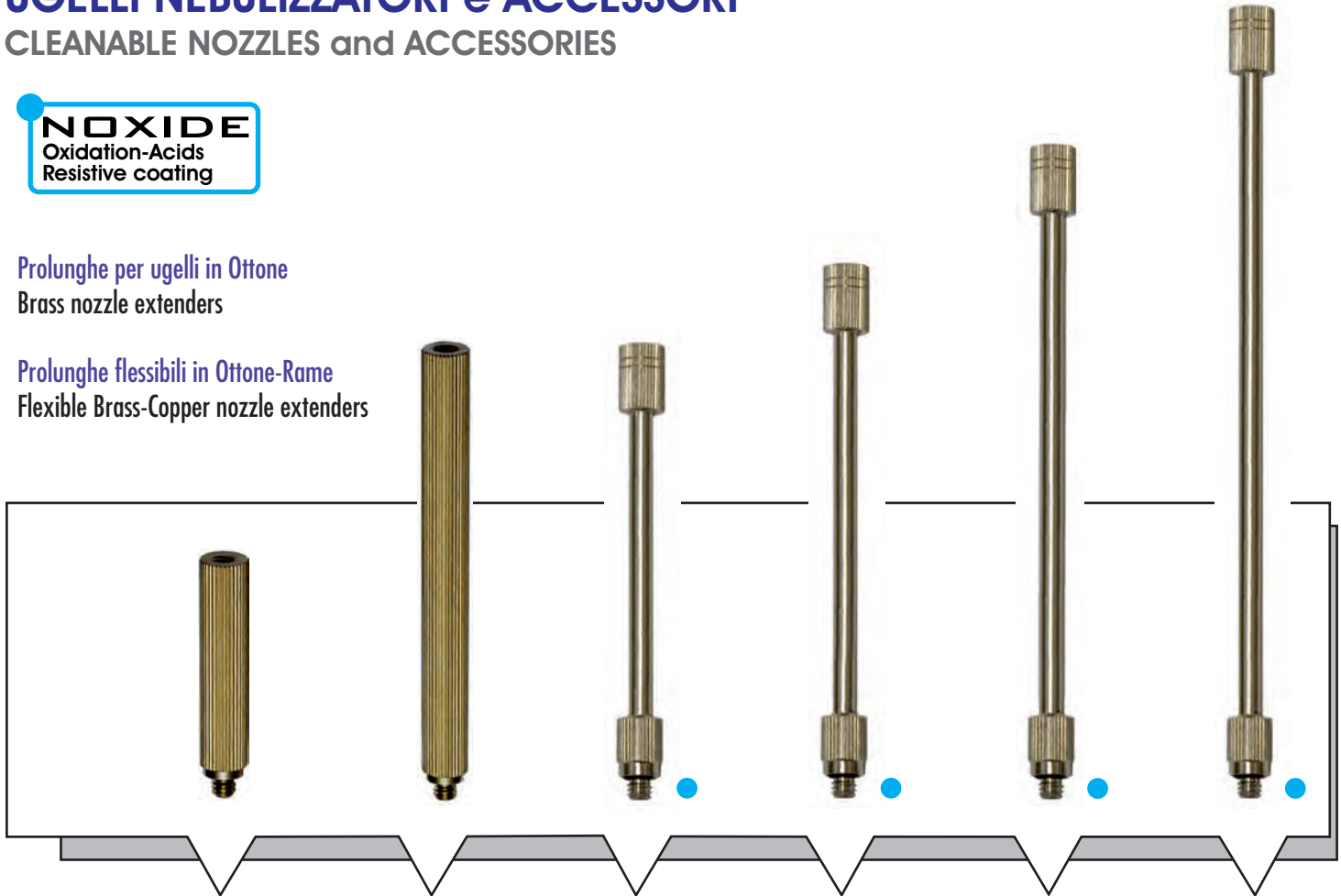

Cod.	IF41010A	IF41010B	IF41010C	IF41015C	IF41020C	IF41030C
Item No.	CV1010-05cm	CV1010-10cm	FLEX-10cm	FLEX-15cm	FLEX-20cm	FLEX-30cm
Lenght	5 cm	10 cm	10 cm	15 cm	20 cm	30 cm
Description	* Filetto Femmina - Female Thread: 10/24" * Filetto Maschio - Male Thread: 10/24"		* Filetto Femmina - Female Thread: 10/24" * Filetto Maschio - Male Thread: 10/24"		* Filetto Femmina - Female Thread: 10/24" * Filetto Maschio - Male Thread: 10/24"	
Prezzo/Price						



Cod.	Item No.	Description
IF410901		Connettore per 4 ugelli ad ombrello 4 nozzles umbrella adapter 1x M10/24" - 4x F10/24"



Cod.	Item No.	Description
IF410902		Connettore per 3 ugelli ad ombrello 3 nozzles umbrella adapter 1x M10/24" - 3x F10/24"



Cod.	Item No.	Description
IF410900		Raccordo orientabile a sfera MF 10/24" Adjustable angle coupling MF 10/24"



## Raccordi speciali per EFFETTI SCENOGRAFICI

Special fittings for FOG EFFECTS

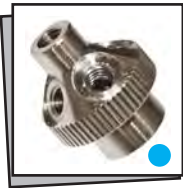

Cod. - Part#	Description	Prezzo/Price
<b>IF300022</b>	* Rosa 5 ugelli 1/8" F - 5x Nozzle holder F 1/8" G * Per nr. 5 ugelli con filetto 10/24unc * For no. 5 nozzles thread 10/24unc	

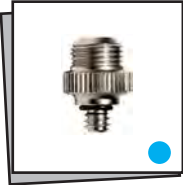

Cod. - Part#	Description	Prezzo/Price
<b>IF300023</b>	Niplo M 1/8" G - M 10/24unc Noxide - Noxide nipple M 1/8" G - M 10/24unc * Filetto - Thread: M 1/8" G - M 10/24unc	



MOST COMMON PARTS FOR FOG EFFECTS  
PARTI SUGGERITE PER EFFETTO NEBBIA

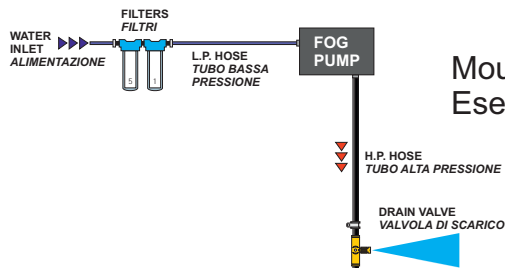
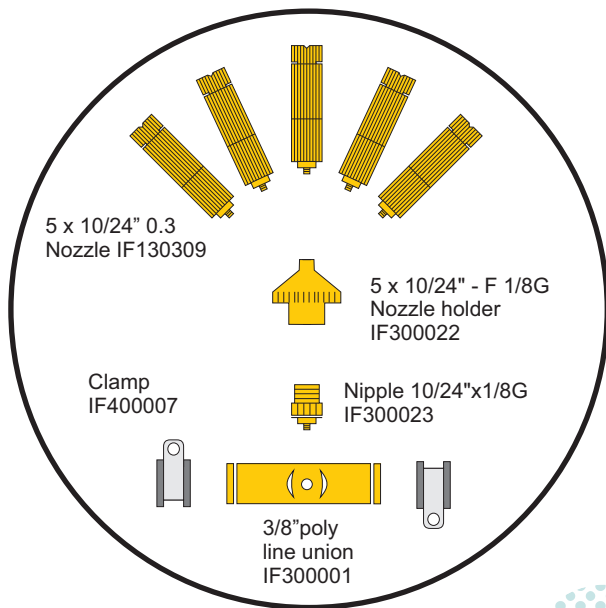

Mounting layout example  
Esempio installazione

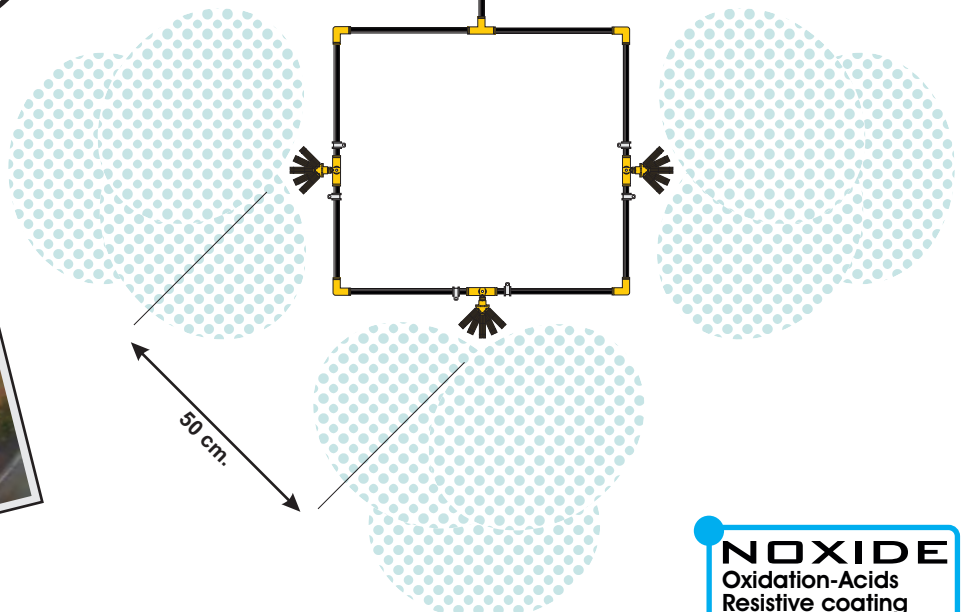

**NOXIDE**  
Oxidation-Acids  
Resistive coating



## COOLING FANS / ACCESSORIES

---



**LINEA VENTILAZIONE**  
MIST COOLING FANS

**La fusione tra ventilazione e nebulizzazione offre la soluzione più potente ed il migliore risultato per il sistema di rinfrescamento specialmente in caso di alti livelli di umidità relativa.**

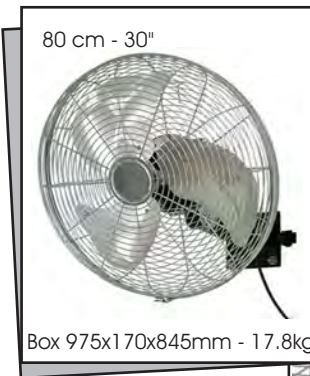

**Ventilatore industriale per montaggio a parete - Heavy duty Wall Mounting fan**

Cod.	Descrizione	Description
<b>IF600029</b>	IF600029 - 220-240V 50/60Hz Ventilatore assiale 80 cm a 3 velocità montaggio a parete con staffa di fissaggio con brandeggio 90° Velocità aria 507 m/min Portata 15.000 m3/h Emissione acustica: 42,2 dB(A) Potenza: 139W (0.65 A) Certificato EN60335-1/EC60335-2-80	IF600029 - 220-240V 50/60Hz 3 speed axial mist cooling fan - dia. 80 cm wall mounting - standard bracket included 90° luffing Air speed 507 mt/min Air flow 15,000 m3/h Background noise level: 42,2 dB(A) Power: 139W (0.65 Amps) EN60335-1/EC60335-2-80 Compliant



**Ventilatore industriale per montaggio a parete - Heavy duty Wall Mounting fan**

Cod.	Descrizione	Description
<b>IF600001</b>	IF600001 - 230V 50/60Hz Ventilatore assiale 60 cm a 3 velocità montaggio a parete con staffa di fissaggio con brandeggio 70° Velocità aria 507 mt/min Portata 12.500 m3/h Emissione acustica: 42.2 dB(A) Potenza: 167W (0.72 A) Certificato: EN60335-1/EC60335-2-80	IF600001 - 230V 50/60Hz 3 speed axial mist cooling fan - dia. 60 cm wall mounting - standard bracket included 70° oscillation and tilting Air speed 507 mt/min Air flow 12,500 m3/h Background noise level: 42.2 dB(A) Power: 167W (0.72 Amps) EN60335-1/EC60335-2-80 compliant

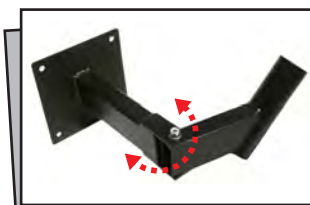

**Staffa orientabile per ventilatore IF600001 - Adjustable Tilting Wall Mount Bracket for IF600001 fan**

Cod.	Descrizione	Description
<b>IF600008</b>	Staffa per montaggio a parete con braccio orientabile di 180° adatta al posizionamento in angolo	Wall mount bracket with 180° adjustable arm suitable for angle mounting

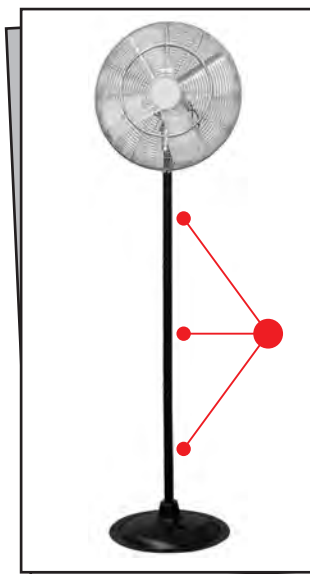

**Piedistallo in 3 pz. per ventilatore IF600001 - 3 pcs. pedestal for IF600001 fan**

Cod.	Descrizione - Description
<b>IF600002</b>	In 3 pz. - Altezza massima 175 cm. 3 pcs. max. height 175 cm.



**LINEA VENTILAZIONE**  
MIST COOLING FANS

**Per la climatizzazione di grandi ambienti, i sistemi di nebulizzazione industriali offrono enormi vantaggi grazie alle elevate prestazioni ed ai consumi ridotti, se paragonati ai sistemi tradizionali.**

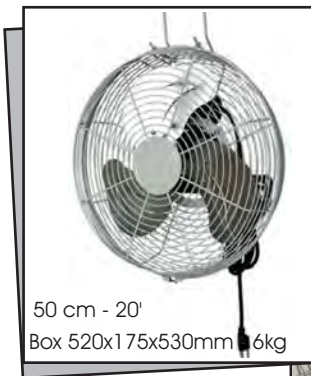

**Ventilatore industriale a sospensione - Heavy duty Hanger fan**

Cod.	Descrizione	Description
<b>IF600050</b>	IF600050 - 220-240V 50/60Hz Ventilatore assiale 45 cm a 3 velocità per montaggio in sospensione senza oscillazione con accessori per fissaggio Velocità aria 200 m/min Portata 6.500 m3/h Emissione acustica: 42.2 dB(A) Potenza: 75W (0.34 A)	IF600050 - 220-240V 50/60Hz 3 speed axial mist cooling fan - dia. 45 cm roof mountig - non-oscillating mounting accessories included Air speed 200 m/min Air flow 6,500 m3/h Background noise level: 42.2 dB(A) Power: 75W (0.34 Amps)

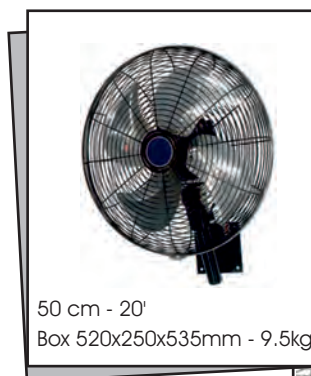

**Ventilatore industriale per montaggio a parete - Heavy duty Wall Mounting fan**

Cod.	Descrizione	Description
<b>IF600041</b>	IF600041 - 220-240V 50/60Hz Ventilatore assiale 50 cm a 3 velocità montaggio a parete con staffa di fissaggio con brandeggio 90° adatto per uso interno (motore ventilato) Velocità aria 310 m/min Portata 9.500 m3/h Emissione acustica: 43 dB(A) Potenza: 88W (0.40 A) certificato EN60335-1 / EC60335-2-80	IF600041 - 220-240V 50/60Hz 3 speed axial mist cooling fan - dia. 45 cm wall mounting - standard bracket included 90° luffing suitable for indoor use (open type motor) Air speed 310 mt/min Air flow 6,400 m3/h Background noise level: 43 dB(A) Power: 88W (0.40Amps) EN60335-1 / EC60335-2-80 compliant



**Ventilatore industriale a sospensione - Heavy duty Hanger fan**

Cod.	Descrizione	Description
<b>IF600045</b>	IF600045 - 230V 50Hz Ventilatore assiale 45 cm a 3 velocità con oscillazione staffa a parete inclusa Portata 9.000 m3/h Emissione acustica: 42.2 dB(A) Potenza: 140W (0.60 A)	IF600045 - 230V 50Hz 3 speed axial mist cooling fan - dia. 45 cm oscillating -mounting accessories included Air flow 9,000 m3/h Background noise level: 42.2 dB(A) Power: 140W (0.60 Amps)



**Ventilatore industriale carellato - Heavy duty Mobile Blower Fan**

Cod.	Descrizione	Description
<b>IF600030</b>	TC-TANK - 230V 50/60Hz Ventilatore assiale 90 cm 3 velocità su carrello mobile, reversibile 360° con possibilità di fissaggio a parete Velocità aria 441 m/min Portata 15800 m3/min Emissione acustica: 56 dB(A) Potenza: 256W (1.36 A) - 960 RPM Certificato: EN60335-1/EC60335-2-80	TC-TANK - 230V 50/60Hz 3 speed axial mist cooling fan - dia. 90 cm on trolley - 360° slewing optional wall mounting Air speed 441 m/min Air flow 15800 m3/min Background noise level: 56 dB(A) Power: 256W (1.36 Amps) - 960 RPM EN60335-1/EC60335-2-80 compliant

## LINEA VENTILAZIONE MIST COOLING FANS

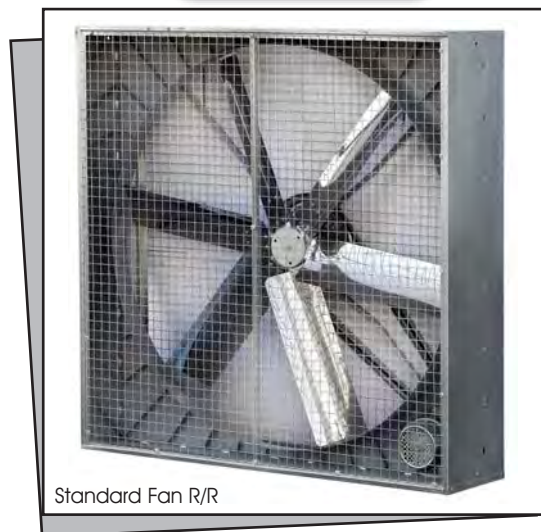

Standard Fan R/R



Exhaust Fan R/S

**I nostri ventilatori ed estrattori industriali offrono la più consistente portata ed operano in modo silenzioso ed efficiente. Il telaio in lamiera zincata progettato per usi industriali è estremamente robusto, compatto e si presta ad una facile installazione. Gli estrattori sono dotati di robuste serrande automatiche. L'alta velocità di rotazione fornisce la massima capacità di raffreddamento con bassi consumi elettrici.**

### Ventilatori industriali cassonati - Heavy duty Box fans

Descrizione	Description
Voltaggio 400V-50Hz	Voltage: 400V-50Hz
Motore monofase fornito su richiesta	Single phase electric motor on request
Protezione rete anteriore e posteriore per montaggio in sospensione o a parete con staffe custom	Double side net protection roof mountig - non-oscillating or wall - bracket mounting
Portata da 12.000 a 40.000 m3/H	Air flow from 12000 up to 40000 m3/H
Emissione acustica: 61 dB(A)	Noise level of fan, background noise level: 6
Lamiera zincata / 6 pale in acciaio inox	Galvanized steel / Six s.steel blades
Trasmissione a cinghia	Belt drive

### Estrattori industriali cassonati - Heavy duty Exhaust Box fans

Descrizione	Description
Voltaggio 400V-50Hz	Voltage: 400V-50Hz
Motore monofase fornito su richiesta	Single phase electric motor on request
Protezione con rete posteriore	Rear side net protection
Serranda anteriore automatica per montaggio in sospensione o a parete con staffe custom	Front side automatic shutter roof mountig - non-oscillating or wall - bracket mounting
Portata da 12.000 a 40.000 m3/H	Air flow from 12000 up to 40000 m3/H
Emissione acustica: 61 dB(A)	Background noise level: 61 dB(A)
Lamiera zincata / 6 pale in acciaio inox	Galvanized steel / Six s.steel blades
Trasmissione a cinghia	Belt drive

Code Codice	Model Versione	Dimensions Dimensioni		Air flow Portata		Power Potenza		Volt 50Hz	Weight Peso Kg
		LxH cm	P cm	M3/h	CFM	W	HP		
IF600162	140	138	33	40000	23500	745	1.00	400	50
IF600163	120	115	33	27000	15900	560	0.75	400	40
IF600164	100	96	33	15000	8800	370	0.50	400	32
IF600165	80	80	33	11000	6500	370	0.50	400	28

Code Codice	Model Versione	Dimensions Dimensioni		Air flow Portata		Power Potenza		Volt 50Hz	Weight Peso Kg
		LxH cm	P cm	M3/h	CFM	W	HP		
IF600172	140	138	45	40000	23500	745	1.00	400	70
IF600173	120	115	45	27000	15900	560	0.75	400	50
IF600174	100	96	45	15000	8800	370	0.50	400	44
IF600175	80	80	45	11000	6500	370	0.50	400	32

**100% Made in Italy:**  
 • S.STEEL blades  
 • Pale in Acciaio INOX

**Our standard and exhaust fans offers high volume output and smooth, efficient operation. The heavy duty galvanized housing is strong, compact, and easy to install. Automatic shutters are included in the exhaust models. The high velocity air pattern provides maximum cooling at the lowest electrical cost.**

## LINEA VENTILAZIONE

### MIST COOLING FANS- ACCESSORIES



Ghiera portaugelli 4 fori d.32 cm - Misting ring 4 Holes d.32 cm

Cod.	Item No.	Descrizione	Description
IF600003	Ring 4	Ghiera portaugelli in acciaio inox 316 con 4 manicotti saldati filettatura 10/24" diam. 32 cm. per ventilatori da 45 cm con innesto F 1/4"	Aisi 316 s.steel misting ring 4 holes thread 10/24" dia. 32 cm. suitable for 45cm fans F 1/4" hose connection



Ghiera portaugelli 5 fori d.40 cm - Misting ring 5 Holes d.40 cm

Cod.	Item No.	Descrizione	Description
IF600004	Ring 5	Ghiera portaugelli in acciaio inox 316 con 5 manicotti saldati filettatura 10/24" diam. 40 cm. per ventilatori da 60 cm con innesto F 1/4"	Aisi 316 s.steel misting ring 5 holes thread 10/24" dia. 40 cm. suitable for 60cm fans F 1/4" hose connection

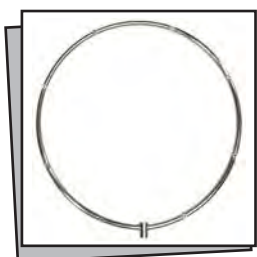

Ghiera portaugelli 8 fori d.47 cm - Misting ring 8 Holes d.47 cm

Cod.	Item No.	Descrizione	Description
IF600005	Ring 8-47	Ghiera portaugelli in acciaio inox 316 con 8 manicotti saldati filettatura 10/24" diam. 47 cm - per ventilatori 60-100 cm con innesto F 1/4"	Aisi 316 s.steel misting ring 8 holes thread 10/24" dia. 47 cm - suitable 60-100 cm. fans F 1/4" hose connection

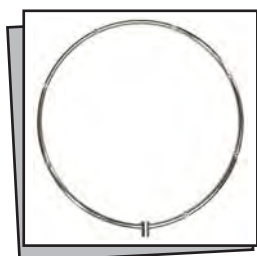

Ghiera portaugelli 8 fori d.80 cm - Misting ring 8 Holes d.80 cm

Cod.	Item No.	Descrizione	Description
IF600006	Ring 8-80	Ghiera portaugelli in acciaio inox 316 con 8 manicotti saldati filettatura 10/24" diam. 80 cm - per ventilatori 100-140 cm con innesto F 1/4"	Aisi 316 s.steel misting ring 8 holes thread 10/24" dia. 80 cm - suitable FOR 100-140 cm. fans F 1/4" hose connection



**Misting fans are the best solution for open areas, to provide air flow and cooling with the best efficiency. The two integrated systems, ventilation and misting, together ensure the best result against the high levels of relative humidity in the hot seasons.**

**LINEA VENTILAZIONE**  
MIST COOLING FANS - accessorie



Industrial and farm installations  
*Installazioni industriali ed allevamenti*



Housing detail  
*Dettaglio del telaio*



**Wall mount bracket for box fan**

**Description**

Wall mount bracket for box fan with 180 adjustable arm and tilting

**Code**

IF600168

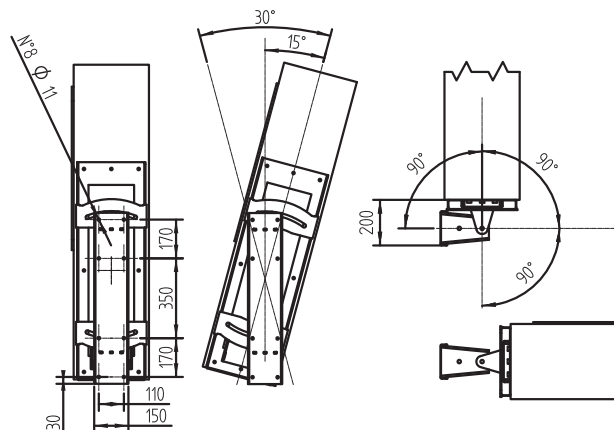
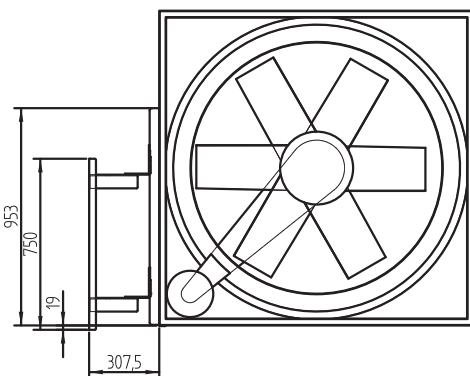
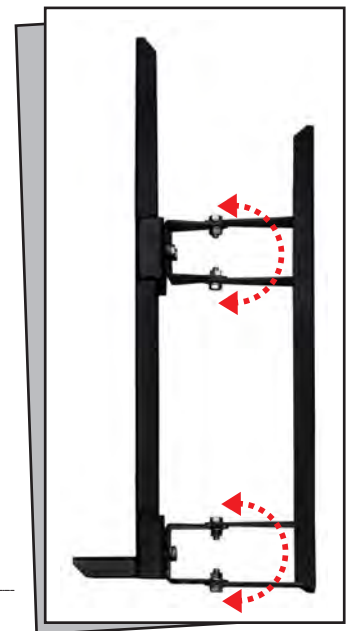

## EUROJET

### A revolutionary cooling and humidification system for large outdoor and indoor areas.

Eurojet has been developed and realized by technical experts and industrial designers to guarantee the best cooling of outdoor areas in hot ambient temperatures and excellent humidification for industrial applications.

The system is combination of ventilation and fogging. Eurojet systems operate by the physical principle of evaporative cooling, creating a thin fog.

Double filtered 1 - 5 micron water is pressurized at 70 bar and distributed along pressure pipes, then sprayed through special patented high pressure nozzles as an extra thin mist. Billions of smaller than 10 micron droplets will refresh the atmosphere.

This fog in ambient hot air will dry off, lowering heat, reducing temperature of even 10 - 15 °C (50 - 60 °F) of ambient temperature.

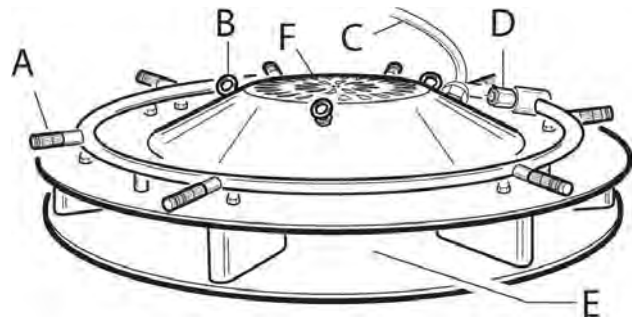

A=Ugelli-Nozzles, B=Golfari di aggancio-Chain Hooks-, C=Cavo elettrico-Electric cable, D=Ingresso acqua-Water inlet, E=Bocche uscita aria-Air outlet, F=Ingresso aria-Air inlet

Eurojet is a noiseless system, italian design, efficient and elegant which matches with the most modern architecture designs.

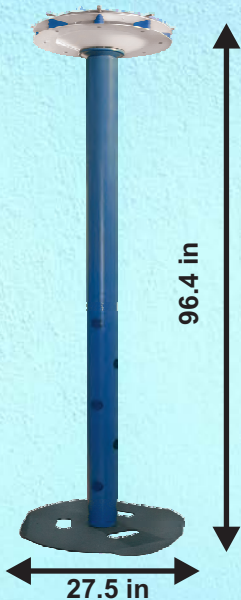

#### TECHNICAL FEATURES

- Fan: Radial 360°
- Voltage: 230V
- Current: 50/60 Hz
- Flow rate: 18710 ft3/h
- Speed: 1410 RPM
- Power: 55 Watt
- Dimensions: 20.9 in x 7.1 in (EC600061)
- Dimensions: 27.5 in x 96.5 in (EC600062)
- Nozzle qty.: 8
- Area coverage: 376 sqf
- Material: Aluminum, S.Steel, others

Aluminium epossidyc painted column



#### USES

Amusement parks, playgrounds, coffeeshops, bars, open air restaurants, hotels, recreation parks, shopping centers, sport resorts, golf clubs, zoos, pools, concerts discoteques, parties, cerimonies...

Humidification system for wine cellars, textile industry, food industry and many other applications.

Eurojet can be installed on a column or hanging up to the ceiling

Code Codice	Description Descrizione
IF600061	EUROJET ceiling misting fan
IF600062	EUROJET mist fan with 245 cm. (96.4 in) pedestal

Nozzles are not included



# MISTING TIPS

---

## HOW DO MISTING SYSTEMS WORK?

When connected to a special high pressure pump, water is forced through our patented nozzles and quickly atomized to droplets as small as 5-10 millionths of a meter (5-10 microns). Misting systems will produce billions of tiny droplets that quickly evaporate. This process of evaporation requires energy, taken from the air in the form of heat. The result is a temperature reduction of up to 35 °F (15 °C), depending on the ambient temperature and humidity levels. This is the most common use for misting systems.

When misting systems are placed inside an enclosed area (such as a factory or a greenhouse), where the air exchange is limited, the misting system will continue to increase the humidity level within the environment. Humidity levels as high as 90+% are possible. This makes misting systems them ideal solution for humidification.



## FILTERS

---



## KIT FILTRAZIONE STANDARD e ACCESSORI

### STANDARD FILTERS KIT and ACCESSORIES



Kit filtro **ECONOMY** con accessori - 1x 5" 1/2 - 5 micron IN 3/4F - OUT 10 mm  
1x 5"x1/2 Filter **ECONOMY KIT** - 5 micron - IN 3/4F - OUT 10mm

Cod.  
**IF500006**

**Economy**  
5" - 5 micron



Kit gruppo filtri con accessori e manometro 2x 9" 1/2  
5+1 micron IN 3/4F - OUT 10 mm  
2x 9"x1/2 Filters **KIT** with pressure gauge  
5+1 micron - IN 3/4F - OUT 10mm

Cod.  
**IF500005**

**Standard**  
9" - 1+5 micron



Kit gruppo filtri **ANTIBATTERICO** con accessori e manometro  
2x 9" 1/2 cartucce 5+1+0.005 micron IN 3/4F - OUT 10 mm  
2x 9"x1/2 **ANTIBACTERIAL** Filters **KIT** with accessories and pressure  
gauge 5+1+0.005 micron cartridges IN 3/4F - OUT 10mm

Cod.  
**IF500008**

**Antibacterial**  
9" - 0.005+1+5 micron



Kit gruppo filtri con accessori e manometro 2x 20" 3/4  
5+1 micron IN 3/4F - OUT 10 mm  
2x 20"x1/2 Filters **KIT** with pressure gauge  
5+1 micron - IN 3/4F - OUT 10mm

Cod.  
**IF520020**

**Professional**  
20" - 1+5 micron

- Tutti i filtri sono dotati di cartucce PP a norme FDA e DM 174/2004
- Temperatura min/max di esercizio: 0°C / 60°C
- All filters are equipped with FDA approved PP cartridges
- Min/Max operating temperature: 0°C / 60°C

## RICAMBI e ACCESSORI per KIT FILTRAZIONE

SPARE PARTS and ACCESSORIES for FILTERS KIT



20"

- IF509101** Cartuccia filtro 1 micron 20"  
20" Filter cartridge 1 micron
- IF509105** Cartuccia filtro 5 micron 20"  
20" Filter cartridge 5 micron
- IF509110** Cartuccia filtro 10 micron 20"  
20" Filter cartridge 10 micron

9"3/4

- IF509001** Cartuccia filtro 1 micron 9"  
9" Filter cartridge 1 micron
- IF509005** Cartuccia filtro 5 micron 9"  
9" Filter cartridge 5 micron
- IF509010** Cartuccia filtro 10 micron 9"  
9" Filter cartridge 10 micron

5"

- IF509006** Cartuccia filtro 5 micron 5"  
5" Filter cartridge 5 micron

Cod.	Description
------	-------------



- |                 |  |
|-----------------|--|
| <b>IF508002</b> | Raccordo diritto 1/2"M-10 ottone<br>Push-in brass connection<br>1/2"Mx10mm |
|-----------------|--|



- |                 |   |
|-----------------|---|
| <b>IF508001</b> | Nipplo 1/2 MM ottone<br>1/2"MM brass coupling |
|-----------------|---|



- |                 |  |
|-----------------|--|
| <b>EC508007</b> | Riduzione 1/2"M-3/4"M ottone<br>1/2"M 3/4"M brass coupling |
|-----------------|--|



- |                 |  |
|-----------------|--|
| <b>IF508008</b> | Tubo di carico 3/4"FF 200 cm.<br>Inlet water hose 3/4"FF 200 cm. |
|-----------------|--|



- |                 |  |
|-----------------|--|
| <b>IF508006</b> | Tubo di raccordo alla pompa<br>10x8 plastico 150 cm.<br>10x8 plastic hose 150 cm |
|-----------------|--|



- |                 |  |
|-----------------|--|
| <b>IF508009</b> | Dispositivo anticalcare<br>magnetico 1/2" MF<br>Anti-calc device 1/2" MF |
|-----------------|--|



Cod.	Description
------	-------------

- |                 |   |
|-----------------|---|
| <b>IF909091</b> | Staffa per 2 filtri<br>Double filter wall-bracket |
| <b>IF909092</b> | Staffa per 1 filtro<br>Single filter wall-bracket |



- |                 |   |
|-----------------|---|
| <b>IF509091</b> | Contenitore per filtro 5"<br>5" Cartridge container |
|-----------------|---|

- |                 |  |
|-----------------|--|
| <b>IF509090</b> | Contenitore per filtro 9"3/4"<br>Cartridge container 9"3/4 |
|-----------------|--|

- |                 |   |
|-----------------|---|
| <b>IF509093</b> | Contenitore per filtro 20"<br>20" Cartridge container |
|-----------------|---|

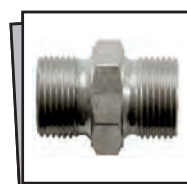

- |                 |  |
|-----------------|--|
| <b>IF508013</b> | Nipplo 3/4" MM ottone<br>3/4"MM brass coupling |
|-----------------|--|



- |                 |   |
|-----------------|---|
| <b>IF508010</b> | Manometro 0-12 BAR 1/8"<br>post.<br>Pressure gauge 0-12 BAR |
|-----------------|---|



- |                 |  |
|-----------------|--|
| <b>IF508011</b> | Prolunga 1/8" MF ottone<br>1/8"MF brass coupling |
|-----------------|--|

## GRUPPO FILTRANTE ANTIBATTERICO e ACCESSORI

### ANTIBACTERIAL FILTERS KIT and ACCESSORIES



**IF509002** Filtro ANTIBATTERICO  
0.005 micron 1/2" MM  
Antibacterial filter  
0.005 micron 1/2" MM



**IF508012** Manicotto ottone  
1/2" FF  
Brass adapter 1/2" FF

#### FILTRO ANTIBATTERICO 0.005 MICRON

Questa cartuccia ultrafiltrante assicura una protezione completa contro batteri, virus ed endotossine contenute nell'acqua, impedendo il contrarre malattie come Legionella e Salmonella.

Grazie alla ultrafiltrazione delle fibre a membrana cava sviluppate per applicazioni mediche, impedisce a qualsiasi sostanza con peso molecolare superiore ai 15K daltons di penetrare attraverso le membrane. Batteri, virus ed endotossine non riescono ad oltrepassare questa barriera grazie a due meccanismi: uno basato sulla funzione di setaccio dei pori (grazie alla configurazione spugnosa) ed uno basato sulla capacità di assorbimento propria delle membrane.

Nota: è obbligatoria la prefiltrazione a 1 micron.

#### ANTIBACTERIAL 0.005 MICRON FILTER CARTRIDGE

This ultrafilter ensure a complete protection against bacteria, virus and endotoxins in the water, avoiding the contraction of diseases like Legionella and Salmonella.

Thanks to the hollow fiber ultrafiltration membrane developed for medical applications, it prevents all substances with a molecular weight higher than 15K daltons crossing over the membrane. Bacteria, viruses and endotoxins cannot pass the membrane barrier due to two mechanisms: one based on the sieving of the pores thanks to the sponge-like configuration and one on the adsorption capability of the membrane itself.

Note: 1 microns prefiltration is mandatory.

Struttura fibre cave  
Hollow fiber structure



Sezione fibra cava  
Hollow fiber section

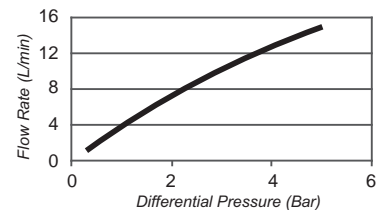
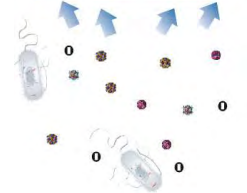
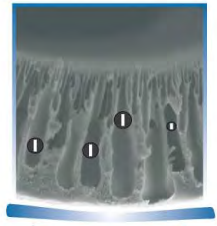

Antibacterial Filter KIT  
9" - 0.005+1+5 micron

Kit gruppo filtri ANTIBATTERICO con accessori e manometro  
2x 9" 1/2 cartucce 5+1+0.005 micron IN 3/4F - OUT 10 mm

2x 9"x1/2 ANTIBACTERIAL Filters KIT with accessories and pressure gauge 5+1+0.005 micron cartridges IN 3/4F - OUT 10mm

Cod.  
**IF500008**

Batteri/Bacteria (P.Diminuta)	10 Log
Virus (PhiX-174)	8 Log
Endotossine/Endotoxins (EU/ml)	5 Log

Retention capacity - Riduzione Log

#### 100% A PROVA DI LEGIONELLA

- Protezione completa contro batteri, virus, endotossine
- Testato clinicamente dal Dipartimento di Igiene Universitario
- Garantisce protezione durevole anche con portate elevate
- Facile installazione
- Protezione totale: filtrazione a 0.005 micron

#### 100% LEGIONELLA-PROOF

- Whole protection against bacteriae, virus, endotoxins in the water
- Clinically tested by Hygiene Department of Italian University
- Guarantees long-lasting protection also with high flows
- Easy set-up
- Total protection: filtration 0.005 micron

## Sterilizzatori ad ultravioletti (UV)

### U.V. Sterilizers



#### Sterilizzatori UV in acciaio inox - UV Stainless Steel sterilizers

Cod.	Item No.	Description
<b>IF509101</b>	UVS-6L	Sterilizzatore UV 6 l/min 16W acciaio inox UV sterilizer 6 l/min 16W S.Steel 1/4 MM - 230V - d. 64 x 340 mm
<b>IF509102</b>	UVS-19L	Sterilizzatore UV 19 l/min 25W acciaio inox UV sterilizer 19 l/min 25W S.Steel 1/2 MM - 230V - d. 64 x 520 mm
<b>IF509103</b>	UVS-25L	Sterilizzatore UV 25 l/min 30W acciaio inox UV sterilizer 25 l/min 30W S.Steel 3/4 MM - 230V - d. 64 x 970 mm
<b>IF509104</b>	UVS-38L	Sterilizzatore UV 38 l/min 55W acciaio inox UV sterilizer 38 l/min 55W S.Steel 3/4 MM - 230V - d. 64 x 970 mm

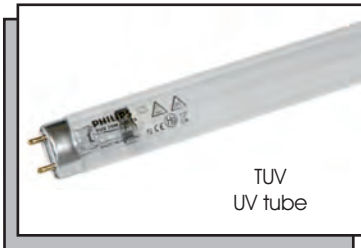

#### Lampade germicide TUV o equivalenti per sterilizzatori UVS - Germicidal Tube TUV (or equivalent) for UVS sterilizers

Cod.	Item No.	Description
<b>IF509151</b>	TUV-16W	Lampada TUV 15/16W o equivalente Germicidal Tube TUV 15/16W or equivalent
<b>IF509152</b>	TUV-25W	Lampada TUV 25W o equivalente Germicidal Tube TUV 25W or equivalent
<b>IF509153</b>	TUV-30W	Lampada TUV 30W o equivalente Germicidal Tube TUV 30W or equivalent
<b>IF509154</b>	TUV-55W	Lampada TUV 55W o equivalente Germicidal Tube TUV 55W or equivalent

#### CARATTERISTICHE TECNICHE

**IT** - Impianti di sterilizzazione a raggi ultravioletti della serie UVS costruiti con corpo in acciaio inox dotati di sistema di allarme visivo esaurimento/malfunzionamento lampada. Le lampade germicide ad ultravioletti serie TUV, sono impiegate negli sterilizzatori per la disinfezione professionale dell'acqua. Queste lampade offrono una emissione UV costante nell'arco della loro vita, garantendo la massima sicurezza nella disinfezione ed una elevata efficacia del sistema. La lunga durata permette di pianificare in anticipo la manutenzione.

- pressione massima di esercizio: 6 bar
- durata funzionamento lampade: 8000 h
- dosaggio radiazione ultravioletta: 30.000 W/cm<sup>2</sup>

#### TECHNICAL FEATURES

**EN** - Impianti di sterilizzazione a raggi ultravioletti della serie UVS costruiti con corpo in acciaio inox dotati di sistema di allarme visivo esaurimento/malfunzionamento lampada. TUV lamps are UVC (germicidal) lamps used in professional water disinfection units. TUV lamps offer constant UV output over their complete lifetime, for maximum security of disinfection and high system efficacy. Moreover, they have a long and reliable lifetime, which allows maintenance to be planned for in advance.

- max. operating pressure: 6 bar - 87 psi
- TUV lamps lifetime: 8000 h
- ultraviolet radiation: 30.000 W/cm<sup>2</sup>

# MISTING TIPS

---

## HOW MUCH WATER WILL IT USE?

The number and size of nozzles are the primary factors in determining how much water your misting system will use..



## CONTROL DEVICES

---





## STRUMENTI di CONTROLLO CONTROL DEVICES



IT-PRO-M

**Igrostato digitale - Presa femmina + cavo spina Schuko 2 m. - Sonda professionale**

**Humidity regulator - Schuko Female socket with el. cable 2 m. length - Professional**

Cod.	Item No.	Working Range	V-Hz	A
<b>IF100001</b>	<b>#IT-PRO-M</b>	<b>from 5 to 95 % r.H.</b>	<b>230-50</b>	<b>8</b>

EN - IT-PRO series humidity regulators are designed to control misting pumps and other equipment (single-phase or three-phase, max. 8 A). It is possible to adjust the desired humidity level by means of a digital display. The step of adjustment is 0,1 or 1%RH. Regulator is available in wall-mount plastic box. Regulator contains a microprocessor based control circuitry and an external humidity sensor in a protection cover.

Computerized design ensures maximum long term stability and temperature compensation of the humidity sensor. State-of-the-art digital sensor ensures excellent calibration, long term stability, inertia against water and condensation.



IT-PRO-T

**Igrostato digitale - Presa femmina trifase + cavo el. 2 m. - Sonda professionale**

**Humidity regulator - 3PH female socket + Electric cable 2 m. length - Professional**

Cod.	Item No.	Working Range	V-Hz	A
<b>IF100008</b>	<b>#IT-PRO-T</b>	<b>from 5 to 95 % r.H.</b>	<b>400-50</b>	<b>8</b>

IT - Gli igrostatii digitali serie IT-PRO consentono il controllo dei moduli pompa e di altri apparecchi, con alimentazione monofase o trifase con assorbimento fino ad 8 A. E' possibile impostare il livello di umidità desiderato mediante un display digitale. Consente di intervenire con step di regolazione di 0,1 o 1%RH. L'igrostatto è predisposto per il fissaggio a parete. La componentistica è basata su un controllo a microprocessore ed una sonda esterna professionale ad alta sensibilità.

L'elettronica digitale assicura la massima stabilità nel tempo e la compensazione di temperatura del sensore di umidità. Il sensore digitale ad alta precisione assicura un'eccellente calibrazione, stabilità e resistenza in presenza di acqua e condensa.



TT-PRO-M

**Termostato digitale - Presa femmina + cavo spina Schuko 2 m. - Sonda professionale**

**Thermostat - Schuko Female socket with el. cable 2 m. length - PT100 professional**

Cod.	Item No.	Working Range	V-Hz	A
<b>IF100002</b>	<b>#TT-PRO-M</b>	<b>-50+200 °C / -58+392 °F</b>	<b>230-50</b>	<b>8</b>

EN - TT-PRO series thermostats are designed to control misting pumps and other equipment (single-phase or three-phase, max. 8 A). It is possible to adjust the desired temperature level by means of a digital display. The step of adjustment is 0,1 or 1% °C or °F. Regulator is available in wall-mount plastic box. Regulator contains a microprocessor based control circuitry and an external temperature probe. Computerized design and state-of-the-art high quality probe ensure excellent calibration and long term stability.

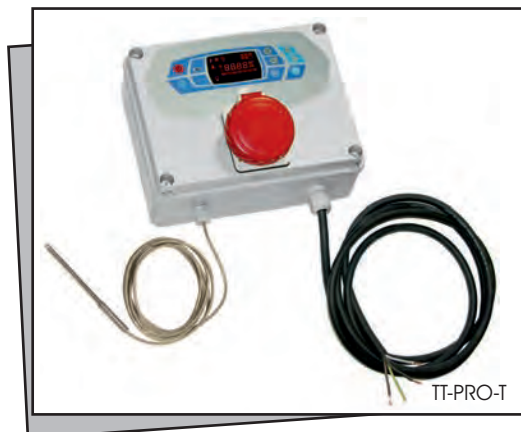

TT-PRO-T

**Termostato digitale - Presa femmina trifase + cavo el. 2 m. - Sonda professionale PT100**

**Thermostat - 3PH female socket + Electric cable 2 m. length - PT 100 professional**

Cod.	Item No.	Working Range	V-Hz	A
<b>IF100009</b>	<b>#TT-PRO-T</b>	<b>-50+200 °C / -58+392 °F</b>	<b>400-50</b>	<b>8</b>

IT - I termostati digitali serie TT-PRO consentono il controllo dei moduli pompa e di altri apparecchi, con alimentazione monofase o trifase con assorbimento fino ad 8 A. E' possibile impostare il livello di umidità desiderato mediante un display digitale. Consente di intervenire con step di regolazione di 0,1 o 1% °C o °F. Il termostato è predisposto per il fissaggio a parete. La componentistica è basata su un controllo a microprocessore ed una sonda esterna professionale ad alta sensibilità.

L'elettronica digitale e la sonda ad alta precisione assicurano un'eccellente calibrazione, stabilità e resistenza nel tempo.

## STRUMENTI di CONTROLLO CONTROL DEVICES

EC100021 Schema esemplificativo installazione - Mounting layout example

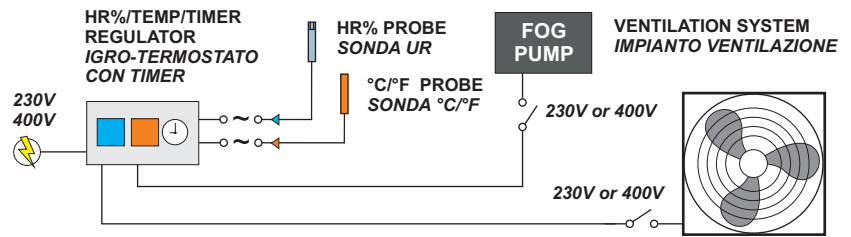

Centralina di controllo per pompa e ventilatori - 230V / 400V

Funzioni di Timer Giornaliero e Settimanale + Igrostatato e Termostato digitali integrate  
Le sonde di umidità IF100031 e di temperatura IF100032 sono fornite separatamente

Pump and ventilation control board - 230V / 400V

Daily and weekly timer with built-in digital Hygrostat and Thermostat

IF100031 humidity transducer and IF100032 temperature transducer are sold

Cod.	Item No.	Working Range	V-Hz	A
IF100021	#TTS.PRO.X	from 5 to 95 % r.H. from -50 to 200 C	230-50 400-50	8

### CARATTERISTICHE TECNICHE

- Igrostatato a 2 punti di intervento, range programmabile
- Termostato a 2 punti di intervento, range programmabile
- Timer giornaliero (9 programmazioni)
- Timer settimanale
- 2 output indipendenti (pompa/ventilatori)
- 2 ingressi segnale indipendenti (temperatura/umidità)
- Alimentazione e output indipendenti a 230V o 400V

### TECNICAL FEATURES

- Hygrostat with two setpoints, adjustable range
- Thermostat with two setpoints, adjustable range
- Daily timer (9 programs)
- Weekly timer
- Two independent outputs (pump/fans)
- Two independent signal inputs (temperature/humidity)
- Power supply and outputs can be wired 230V or 400V

ITTS-PRO series controllers integrate pump and fans controllers plus daily and weekly timer with humidity and temperature regulators. ITTS-PRO controllers are designed to control high pressure pumps (single-phase or three-phase, max. 13 A). A secondary output can control ventilation system (single-phase or three-phase, max. 13 A). The daily timer is able to switch on/off pump+fans at a chosen hour of the day, while the weekly timer let you choose in which days the daily timer must be activated. The controller accepts input signals from humidity and temperature transducers. It is possible to adjust the desired humidity level or temperature by means of a digital display. The step of adjustment is 0,1 or 1%RH and °C/°F. Transducers are sold separately.

ITTS-PRO è un controller che integra funzioni di igrostatato e termostato, inoltre dispone di un timer giornaliero e settimanale. Gestisce l'alimentazione di due sistemi indipendentemente (monofase o trifase, max. 13 A), ad esempio una pompa ed un sistema di ventilazione. La regolazione dell'umidità e temperatura desiderati sono effettuati tramite display digitale con risoluzione 0,1 o 1 RH% e °C/°F. Il timer giornaliero è in grado di accendere/spengere pompa e/o ventilatori ad una determinata ora del giorno, mentre il timer settimanale vi permette di impostare in quali giorni l'impianto deve essere attivato. L'apparecchio è fornito senza sonde.

### Applicazioni Applications

Serre  
Allevamenti  
Cantine vinicole  
Industria alimentare  
Umidificazione industriale  
Greenhouses  
Livestock  
Wineries  
Food industry  
Industrial humidification

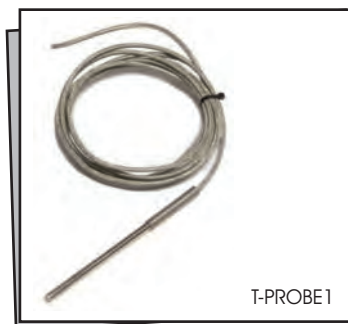

Sonda di temperatura professionale PT-100

Professional Temperature probe PT-100

Cod.	Item No.	Working Range
IF100032	#T-PROBE1	from -50 to 200 °C
	Wires	
	3	



Sonda di umidità UR professionale 0-20mA

Professional Humidity probe UR 20 mA

Cod.	Item No.	Working Range
IF100033	#HR-PROBE2	from 5 to 95 % r.H.
	Signal	
	20 mA	
	Wires	
	2	

**STRUMENTI di CONTROLLO**  
CONTROL DEVICES



Timer digitale 230V 50/60Hz esterno presa Schuko con cavo 2,3 m + Programmazione ciclica con tempi ON/OFF indipendenti da 1 secondo a 99 Programmazione giornaliera e settimanale, con funzione week-end (max. External digital timer 230V 50/60Hz Schuko plug+pin with 2.3 m el. cable. Independent ON/OFF cycles programming from 1 second up to 99 minutes. Daily and weekly programming, with week-end option (max 9 programs).

Cod.	Item No.	Working Range	V-Hz	A	kW
<b>IF100003</b>	#T2.EXT-230	1 sec. - 99 min.	230-50/60	8	1,5
<b>IF100003Y</b>	#T2.EXT-230	1 sec. - 99 min.	120-60	13	



Timer digitale 400V 50/60Hz esterno presa trifase con cavo 2,3 m. Programmazione ciclica con tempi ON/OFF indipendenti da 1 secondo a 99 Programmazione giornaliera e settimanale, con funzione week-end (max. External digital timer 400V 50/60Hz 3PH socket with 2.3 m el. cable. Independent ON/OFF cycles programming from 1 second up to 99 minutes. Daily and weekly programming, with week-end option (max 9 programs).

Cod.	Item No.	Working Range	V-Hz	A	Kw
<b>IF100004</b>	#T2.EXT-400	1 sec. - 99 min.	400-50/60	13	5,7
<b>IF100005</b>	#T2.EXT-400	1 sec. - 99 min.	400-50/60	17	7,5



Timer digitale 230V 50/60Hz esterno presa Schuko con cavo 2,3 m + Programmazione ciclica con tempi ON/OFF indipendenti da 1 a 99 minuti. External digital timer 230V 50/60Hz Schuko plug+pin with 2.3 m el. cable. Independent ON/OFF cycles programming from 1 up to 99 minutes.

Cod.	Item No.	Working Range	V-Hz	A
<b>IF100003</b>	#T.EXT	1 - 99 min.	230-50/60	8



Kit BOX elettrovalvole NC+NO per sistema umidificazione 230V50/60Hz Consente lo scarico di una linea in automatico tramite il controllo di un Automatic drain solenoid valves KIT (NO + NC) - 230V 50/60Hz It allows to automatically drain a pipeline by means of an humidity controller.

Cod.	Item No.	V-Hz	A
<b>IF309031</b>	#KIT.DRAIN1	230-50/60	0,2
<b>IF309031Y</b>	#KIT.DRAIN1	120-60	0,2

## POMPE DOSATRICI e ACCESSORI DOSING PUMPS and ACCESSORIES

Pompe dosatrici a bassa portata destinate alla pre-miscelazione di additivi idrosolubili nel sistema pompante.

Low-volume pumps with controllable discharge rates, used to inject additives into pumping systems.

**PRO** - Pompa dosatrice elettronica professionale con contaltri lanciaimpulsi. Le pompe dosatrici serie PRO sono in grado di effettuare dosaggi proporzionalmente variabili al variare degli impulsi in ingresso oppure con programmazione temporizzata. 230V 50

**PRO** - Electronic metering pump with threaded pulse water meter. PRO series metering pumps accept dry contact inputs and dose proportionally to the input pulse frequency or with timer programming. 230V 50-60Hz

V-Hz	Stroke/min	Connections in/out
230-50/60	400	4/6
Back pressure	Flow rate l/h	cm <sup>3</sup> /Stroke
10	5	0,52
8	6	0,63
2	8	0,83

Cod.  
**IF100004**

**PREMIUM** - Semplice e affidabile pompa dosatrice elettromagnetica basata su microprocessore. Regolazione manuale della portata da 0 (pompa ferma) al 100% della portata massima. IP65.

**PREMIUM** - A simple yet reliable micro-processor based solenoid dosing pump. Flow rate manual adjustment from 0 (operation stop) to 100% of max. flow rate (cm<sup>3</sup>/Stroke). IP65.

V-Hz	Stroke/min	Connections in/out
230-50/60	100 (7bar) - 160 (5bar)	4/6

Cod.	Back pressure	Flow rate
<b>IF100005</b>	7 bar	2 l/h
<b>IF100010</b>	5 bar	5 l/h

**PREMIUM KIT SANIFICAZIONE** - Semplice e affidabile pompa dosatrice elettromagnetica basata su microprocessore. Regolazione manuale della portata da 0 (pompa ferma) al 100% della portata massima. IP65. Con Timer programmato per ciclo di sanificazione.

**PREMIUM SANITIZING KIT** - A simple yet reliable micro-processor based solenoid dosing pump. Flow rate manual adjustment from 0 (operation stop) to 100% of max. flow rate (cm<sup>3</sup>/Stroke). IP65. Complete with Timer programmed for sanitizing cycle.

V-Hz	Stroke/min	Connections in/out
230-50/60	100	4/6

Cod.	Back pressure	Flow rate
<b>IF100011</b>	5 bar	5 l/h

**EASY** - Semplice e affidabile pompa dosatrice peristaltica. Portata fissa regolabile ad intervalli per mezzo del timer a ciclo programmabile in dotazione. IP65.

**EASY** - A simple yet reliable peristaltic dosing pump. Fixed flow rate adjustable by the included programmable digital timer. IP65.

V-Hz	Stroke/min	Connections in/out
230-50/60	Timer	2
Back pressure	Flow rate l/h	cm <sup>3</sup> /Stroke
0,1 bar	1,5	Continuous

Cod.  
**IF100006**



Pro



Premium



Sanitizing



Easy

# MISTING TIPS

---

SHOULD I CONSIDER WINTERIZING MY PUMP?

To prevent freezing and damage, all of the misting system nozzles should be removed. The misting system line, the pump, and the filters should be drained



## SPARE PARTS / ACCESSORIES

---



## ACCESSORI e RICAMBI ACCESSORIES and SPARE PARTS





Cod.	Description	Cod.	Description
 IF309002	Connettore per bobina elettrovalvola tipo C1 Solenoid coil plug C1 version	 IF309023	Elettrovalvola alta pressione NA High pressure solenoid valve NO F1/4" F1/4" 24V AC 60 BAR
 IF309006	Connettore per bobina elettrovalvola tipo C4 Solenoid coil plug C4 version	 IF309024	Elettrovalvola alta pressione NA High pressure solenoid valve NO F1/4" F1/4" 110V60Hz 60 BAR
 IF309007	Elettrovalvola alta pressione NC High pressure solenoid valve NC F1/4" F1/4" 230V50Hz 80 BAR	 IF309025	Elettrovalvola alta pressione NC High pressure solenoid valve NC F1/4" F1/4" 110V60Hz 80 BAR
 IF309005	Elettrovalvola alta pressione NC High pressure solenoid valve NC F3/8" F3/8" 230V50Hz 100 BAR	 IF309026	Elettrovalvola alta pressione NC High pressure solenoid valve NC F3/8" F3/8" 110V60Hz 100 BAR
 IF309015	Elettrovalvola alta pressione NA High pressure solenoid valve NO F1/4" F1/4" 230V50Hz 60 BAR	 IF309027	Elettrovalvola bassa pressione NC Low pressure solenoid valve NC F3/8" F3/8" 110V60Hz 16 BAR
 IF309001	Elettrovalvola bassa pressione NC Low pressure solenoid valve NC F3/8" F3/8" 230V50Hz 16 BAR	 IF309028	Elettrovalvola alta pressione NA High pressure solenoid valve NO F1/4" F1/4" 400V50Hz 60 BAR
 IF309022	Elettrovalvola alta pressione NC High pressure solenoid valve NC F1/4" F1/4" 24V AC 80 BAR	 IF309029	Elettrovalvola alta pressione NC High pressure solenoid valve NC F1/4" F1/4" 400V50Hz 80 BAR
 IF309021	Elettrovalvola alta pressione NC High pressure solenoid valve NC F3/8" F3/8" 24V AC 100 BAR	 IF309030	Elettrovalvola alta pressione NC High pressure solenoid valve NC F3/8" F3/8" 400V50Hz 100 BAR

## ACCESSORI e RICAMBI ACCESSORIES and SPARE PARTS

Cod.	Description	Cod.	Description
	<b>IF309003</b> Pressostato inverso con Reset 230V 50Hz F 3/8" Pressure switch 230V 50Hz F 3/8"		<b>IF309040</b> Scheda elettronica 0. Time Deluxe Control board Oasis Time Deluxe
	<b>IF309010</b> Timer ciclico ON/OFF digitale Digital ON/OFF cyclic timer 230-115V 50-60Hz		<b>IF309041</b> Scheda elettronica 0.Time Deluxe 2 Control board Oasis Time Deluxe 2
	<b>IF100007</b> Programmatore inverter VAR VAR pumps programmer		<b>IF309042</b> Scheda elettronica 0. Pro Deluxe Control board Oasis Pro Deluxe
	<b>IF309015</b> Pressostato 1/4"M BSP Pressure switch 1/4"M BSP 40 BAR 230V 50/Hz - NT		<b>IF309043</b> Scheda elettronica 0. Pro Deluxe Control board Oasis Pro Deluxe 2
	<b>IF309016</b> Pressostato 1/8"M BSP Pressure switch 1/8"M BSP 40 BAR 230V 50/Hz - ARC-POL		<b>IF309044</b> Scheda elettronica per IF100001 Control board for IF100001
	<b>IF309014</b> Kit per alimentazione serbatoio External water tank feeding KIT EVO-POL		<b>IF309045</b> Scheda elettronica TIME 2.0 Control board TIME 2.0
	<b>IF309032</b> Connettore maschio 5P sonde Male plug 5P probes		<b>IF309034</b> Connettore maschio 4P remoto Male plug 4P remote
	<b>IF309033</b> Connettore femmina 5P sonde Female socket 5P probes		<b>IF309035</b> Connettore femmina 4P remoto Female socket 4P remote

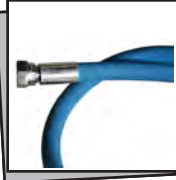
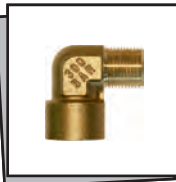
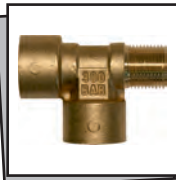
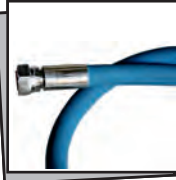
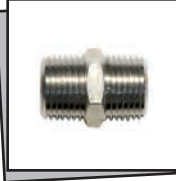

**ACCESSORI e RICAMBI**  
ACCESSORIES and SPARE PARTS

Cod.	Description
 IF400032	Tubo flessibile 5/16" A.P. 1 m High pressure hose 5/16" 1 m F3/8" F3/8" s.steel / inox
 IF400041	Raccordo curvo ottone Elbow fitting - brass M3/8" F3/8" - BSP
 IF400042	Raccordo a T ottone Tee fitting - brass M 3/8" F 3/8" F 3/8" - BSP
 IF400033	Tubo flessibile 1/2" A.P. 1 m High pressure hose 1/2" 1 m F1/2" F1/2" S.Steel / inox
 IF400043	Niplo 1/2" inox BSP S.Steel nipple 1/2" BSP
 IF400044	Raccordo a T ottone Tee fitting - brass F1/2" F1/2" F1/2" BSP
 IF400030	Tubo flessibile 1/4" A.P. 8 m High pressure hose 1/4" 8 m F22X1,5 F1/4" brass / ottone
 IF400031	Tubo flessibile 3/16" A.P. 2,5 m High pressure hose 3/16" 2.5 m F1/4" F1/4" brass / ottone

Cod.	Description
 IF309020	Valvola di non ritorno inox Stainless steel check valve F 1/4" F 1/4" 400 BAR
 IF500009	Sistema filtrante alta pressione 1/4" F x 1/4" F High pressure filter 1/4" F x 1/4" F
 IF400045	Niplo M22x1,5 dia.14 - M1/4" G Nipple M22x1,5 dia.14 - M1/4" G
 IF400046	Attacco girevole F22x1,5 - G1/4" F Quick coupling F22x1,5 - G1/4" F
 IF400011	Valvola a sfera di intercettazione G 1/4" FF 80 bar - ottone G 1/4" FF On/Off brass valve 1150 psi
 IF400013	Valvola a sfera di intercettazione G 1/4" FF - INOX G 1/4" FF On/Off S.Steel Valve





## SPECIAL MACHINES

---



## LIBERTY - Mobicool

### Stand-alone high pressure misting fan

LIBERTY is a stand-alone, high-pressure, low-noise misting fan with cooling effect, belonging to Itai Cooler Family.

Thanks to the built-in pressurization system, LIBERTY is capable of mixing atomized water to the airflow, thus producing a cooling effect all around.

Enjoy a cool summer also outdoor and without fixed installations. LIBERTY is really a special fan, quiet, effective, fully autonomous with a high capacity water tank that guarantees from 3 up to 5 hours of autonomy. LIBERTY is quiet, its electrical QES motor and pump are noiseless, less than 55 DB noise emission, thanks to a low consumption technology designed for applications in environments requiring low noise emissions.

#### TECNICAL FEATURES

- professional high pressure pump with aluminium head
- working pressure: 70 bar
- 3 heavy duty stainless steel pistons
- variable flow rate, built-in by-pass
- safety valve
- heavy duty industrial motor, 550 W self-ventilated
- thermal overload protection
- 60 liters (15.85 Gallons ) water tank
- OFF/FAN-ON/FAN AND MISTING ON switch
- electric float switch level controller to protect pump against dry running
- weight balanced, wheels and handle for easy displacement
- manufactured in compliance with CE regulations
- noise level: 55 dB(A) (average)

**Super Quiet Engine!**  
**Less than 55 dB(A)**

**Area Coverage:**  
**over 50 m<sup>2</sup> !**

**QES:** units supplied with QES low noise motors (Quiet Engine System) are peculiarly preferred in resorts, swimming pools, bars, restaurants, hotels, where noise may disturb your guests.

**BPS:** all units are equipped with By-Pass System (built-in by-pass valve), recirculating the water inside the pump, preventing from pump overheating. Fog systems driven by BPS fog pumps do not require any drain valves to empty the pipe so that no water is wasted on the ground.

#### USES

Gardens, parks, verandas, beaches, public places, bars, restaurants, hotels, swimming pools, sport events, parties, factories, warehouses, shopping malls, discoteques, ceremonies, and any other area to be cooled.

Fill up the tank with clean fresh water, plug-in, switch on. In a while a fresh breeze will make your summer more pleasant.

Code Co dice	Pressure Pressione		Output Portata		Power Potenza		Autonomia Running time	Volt 50Hz	Ugelli Nozzles
	Bar	psi	l/min	gpm	W	Ah	H/Hours		Min/Max
IF600080	70	1000	0,31	0.08	450	2.3	3	230	4 x 0.20
IF600081	70	1000	0,18	0.05	450	2.3	5	230	4 x 0.15



Mobi-Cool

Dimension: h. 2050 x p. 580 x l. 580 mm  
Weight: 50 Kg (empty water tank)



- Reduces flying insects
- Lowers temperature
- Absorbs dust and pollen

## LIBERTY DELUXE - i-Cool

STAND ALONE MISTING FAN

LIBERTY-DELUXE is a stand-alone, high-pressure, low-noise misting fan with cooling effects, belonging to Italfog Family. Thanks to the built-in pressurization system, LIBERTY-DELUXE is capable of mixing atomized water to the airflow, thus producing a cooling effect all around.

Enjoy a cool summer also outdoor and without fixed installations. LIBERTY-DELUXE is really a special fan, quiet, effective, fully autonomous with a high capacity water tank that guarantees from 3 up to 5 hours of autonomy.

LIBERTY-DELUXE is quiet, its electrical QES motor and pump are noiseless, less than 55 dB noise emission, thanks to a low consumption technology designed for applications in environments requiring low noise emissions.

### TECNICAL FEATURES

- professional high pressure pump with aluminium head
- working pressure: 70 bar
- 3 heavy duty stainless steel pistons
- variable flow rate, built-in by-pass
- safety valve
- heavy duty industrial motor, 550 W self-ventilated
- thermal overload protection
- 70 liters (18.5 Gallons ) water tank
- OFF/FAN-ON/FAN AND MISTING ON switch
- digital cyclic timer (min./sec.)
- daily and weekly timer programming (optional)
- water level alarm to protect pump against dry running
- weight balanced, wheels and handle for easy displacement
- manufactured in compliance with CE regulations
- noise level: 55 dB(A) (average)

**QES:** units supplied with QES low noise motors (Quiet Engine System) are peculiarly preferred in resorts, swimming pools, bars, restaurants, hotels, where noise may disturb your guests.

**BPS:** all units are equipped with By-Pass System (built-in by-pass valve), recirculating the water inside the pump, preventing from pump overheat. Fog systems driven by BPS fog pumps do not require any drain valves to empty the pipe so that no water is wasted on the ground.

### USES

Gardens, parks, verandas, beaches, public places, bars, restaurants, hotels, swimming pools, sport events, parties, factories, warehouses, shopping malls, discoteques, ceremonies, and any other area to be cooled.

Fill up the tank with clean fresh water, plug-in, switch on. In a while a fresh breeze will make your summer more pleasant.



**Super Quiet Engine!  
Less than 55 dB(A)**

**Area Coverage:  
over 50 m<sup>2</sup> !**



Dimensions: h. 2050 x p. 580 x l. 580 mm  
Weight: 50 Kg (empty water tank)



Digital control panel

- Reduces flying insects
- Lowers temperature
- Absorbs dust and pollen

i-Cooler										
Code Codice	Pressure Pressione		Output Portata		Power Potenza		Running time Autonomia		Volt 50Hz	Nozzles Ugelli Min/Max
	Bar	psi	l/mn	gpm	W	Ah	H/Hours			
IF600190	70	1000	0,31	0.08	550	2.4	3	230	4 x 0.20	
IF600191	70	1000	0,18	0.05	550	2.4	5	230	4 x 0.15	

## APACHE A-60

powerful and reliable with long lifetime

A-60 is equipped with a high power turbine ventilator and thanks to its three-in-one concentric nozzle rings, it can spray a light rain with a throw of approximately 40-60\* meters (130-170\* feet).

### BENEFITS

- lower labour costs
- better working conditions
- lower wearing of machinery and tools
- less or no puddles and trickles
- lower environmental pollution
- effective dust suppression on open spaces

### APPLICATIONS

Dust suppression and humidification of open dusty surfaces, mining, general demolition work and bulk material handling, waste treatment facilities, stockpiles, discharging into ships, reclaiming from stockpiles, dumping, crushing and loading/unloading trucks.  
Cooling of large open spaces like stadiums, concerts, events, parks.  
Fog and artificial rain effects.

### TECHNICAL FEATURES

- Recommended working pressure 7-10 BAR
- Min. working pressure 3 BAR (best = 7-10 BAR)
- Nozzle no.: 60 (1 ring by 60 nozzles)
- Max. area coverage 10.700 m2 approx.
- Air flow: 28.500 m3/h
- Water flow:

#### Apache A-60 - FLOW RATES

	Operating Mode		1 Low		2 Medium		3 High	
	Bar	psi	l/m	gpm	l/m	gpm	l/m	gpm
Water flow	10	145	30	7.92	60	15.84	90	23.76
Water flow	7	100	23	6.07	46	12.15	70	18.49
Water flow	3	44	15	3.96	30	7.92	45	11.88

### ELECTRICAL FEATURES

- Absorbed power: 11 kW
- Voltage: 400V 50Hz (3P+N+G plug)
- IP protection: IP55

### MECHANICAL FEATURES

- Rotation: 340°
- Elevation: -20° +45°
- Fan diameter: 660mm (26 in.)
- Fan speed: (RPM) 2800

### PERFORMANCES

- Throw: 60\* meters (170\* feet)
- Noise level < 93 dB(A)

\* with favorable light wind conditions

### CONTROLS

- ON/OFF switch
- LEFT - RIGHT automatic rotation
- Adjustable elevation
- Adjustable/programmable working angle
- Fan start
- Water supply start (water pump/solenoid valves)
- START - STOP timer
- Flashing with alert sound

### OPTIONALS

- Low pressure pump (7 BAR electric pump - 3 kW)
- High pressure pump
- Nozzle ring heater (quick defrost)
- Remote control with battery charger (on/off and movement)



adjustable flow rate

pantograph arm



Anello ugelli.  
Apache A-60 industrial ventilator head view with detail of the three sectors single nozzle ring.



Ventilatore.  
High power ventilator view of the A-60 fog cannon.

# Automation of Misting Systems

The automation division, in close collaboration with product and factory technical management teams, designs and build all the control and command systems for Italfog misting systems.

The supervision systems is realized using high quality products present in the market, such as Siemens, Omron, Schneider Electric, ABB etc, in order to supply:

- Professional control panel with all relevant non-commercial electronics
- Line supervision systems and interface (HMI)
- Special electronic and automation projects

The Automation team also checks that the control solutions on offer respond to the real technical and operative needs of the customer, thus ensuring reliability, precision and user-friendliness.

Thanks to the personalized automation systems every client can control its misting system lines designed for outdoor cooling, dust and odor control.

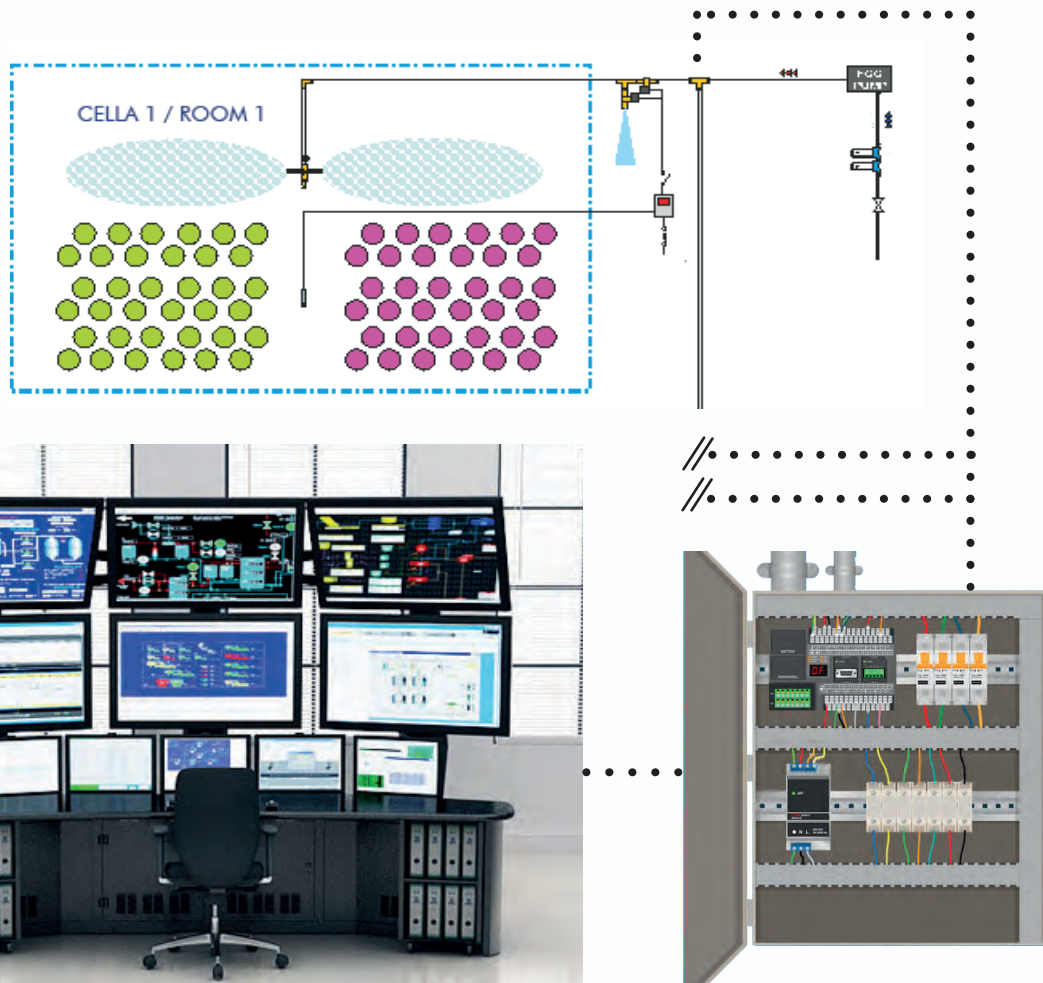







## TABELLA PORTATE UGELLI NEBULIZZATORI FOG NOZZLES FLOW RATES TABLE

Tested with water under controlled Laboratory conditions and 1 U.S. Gallon = 3.78 Liters approx.  
\*\*\*Other orifice sizes available on request.

Dati rilevati da test di laboratorio.  
Conversione 1 U.S. Gallon = 3.78 Litri  
\*\*\*Ugelli con foro/portata fuori standard su richiesta

Tabella: Portata (GPH) (LPH) (LPM) alle pressioni indicate (BAR) (PSI)  
Table: Flow rate (GPH) (LPH) (LPM) versus operating pressure (BAR) (PSI)

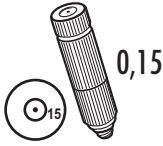
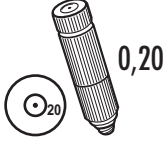
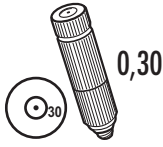
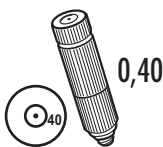
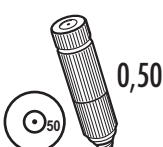
ORIFICE DIAMETER	BAR	3	4	7	10	15	25	35	45	70	84	100
	PSI	42	56	100	142	213	355	500	640	1000	1200	1420
 0,15 .006"/.15 mm	GPH		--	--	--	--	0,44	0,52	0,60	<b>0,73</b>	0,80	0,93
	LPH						1,68	1,98	2,28	<b>2,76</b>	3,06	3,54
	LPM							0,0280	0,0330	0,0380	<b>0,0460</b>	0,0510
 0,20 .008"/.20mm	GPH		--	--	--	--	0,77	0,92	1,05	<b>1,25</b>	1,55	1,60
	LPH						2,88	3,41	3,86	<b>4,72</b>	5,88	6,06
	LPM							0,0480	0,0568	0,0643	<b>0,0787</b>	0,0980
 0,30 .012"/.30mm	GPH	0,37	0,43	0,55	0,68	0,78	1,03	1,23	1,41	<b>1,74</b>	2,52	2,63
	LPH	1,34	1,55	2,05	2,45	3,00	3,87	4,74	5,20	<b>6,48</b>	9,54	9,96
	LPM							0,0645	0,0790	0,0867	<b>0,1080</b>	0,1590
 0,40 .015"/.40mm	GPH	0,51	0,59	0,76	0,93	1,07	1,42	1,69	1,93	<b>2,39</b>	3,09	3,19
	LPH	1,81	2,13	2,81	3,36	4,12	5,32	6,29	7,14	<b>8,90</b>	11,70	12,06
	LPM							0,0887	0,1048	0,1190	<b>0,1483</b>	0,1950
 0,50 .020"/.50mm	GPH	0,69	0,80	1,03	1,26	1,46	1,93	2,31	2,63	<b>3,26</b>	4,23	4,36
	LPH	2,51	2,90	3,83	4,58	5,61	7,24	8,57	9,72	<b>12,12</b>	16,02	16,50
	LPM							0,1207	0,1428	0,1620	<b>0,2020</b>	0,2670

### Area di lavoro richiesta per ugelli standard (valori suggeriti per ugelli 0.15 - 0.20)

### Standard nozzles required work area (suggested values for 0.15 - 0.20 nozzles only)

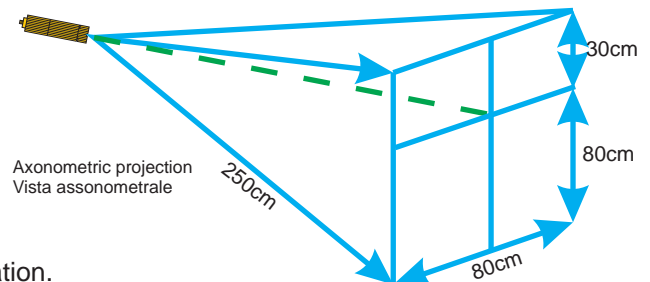
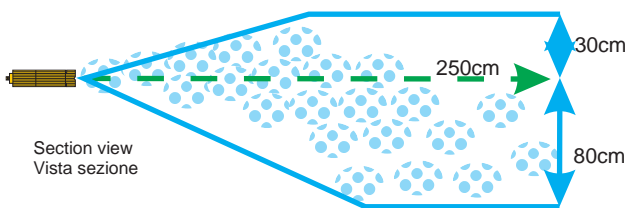

Values may change depending on air temperature, humidity, ventilation.  
I valori possono variare in dipendenza della temperatura dell'aria, umidità e ventilazione.



[www.italfog.com](http://www.italfog.com)

- :: Outdoor cooling
- :: Cooling Fans
- :: Pre-Cooling
- :: Humidification
- :: Odour and dust suppression
- :: Special effects

MADE IN  
ITALY 

**:: ITALFOG**

Via Mariella, 12 - 42123 - Reggio Emilia

Ph. +39 0522 334284

Via Merulana, 259 - 00185 - Rome

Ph. +39 06 56547594

E-mail: [info@italfog.com](mailto:info@italfog.com)